



YAMAHA

XS850G

OWNER'S MANUAL

LIT-11626-01-79

3J3-28199-10

**XS850G OWNER'S MANUAL
1ST PRINTING, JULY 1979
ALL RIGHTS RESERVED,
BY YAMAHA MOTOR COMPANY
LIMITED, JAPAN
PRINTED IN JAPAN
P/N LIT-I 1626-01-79**

IMPORTANT:

PLEASE READ THIS MANUAL CAREFULLY AND COMPLETELY BEFORE OPERATING THIS MOTORCYCLE.

DO NOT ATTEMPT TO OPERATE THIS MOTORCYCLE UNTIL YOU HAVE ATTAINED A SATISFACTORY KNOWLEDGE OF ITS CONTROLS AND OPERATING FEATURES AND HAVE BEEN TRAINED IN SAFE AND PROPER RIDING TECHNIQUES.

REGULAR INSPECTIONS AND CAREFUL MAINTENANCE ARE REQUIRED IN ADDITION TO RIDING SKILL IN ORDER TO ENJOY THE CAPABILITIES AND RELIABILITY OF THIS MOTORCYCLE SAFELY.

Particularly important information is distinguished in this manual by the following notations:

NOTE: A NOTE provides key information to make procedures easier or clearer.

CAUTION: A CAUTION indicates special procedures that must be followed to avoid damage to the motorcycle.

WARNING: A WARNING indicates special procedures that must be followed to avoid injury to a motorcycle operator or person inspecting or repairing the motorcycle.

NOTE: _____

This manual should be considered a permanent part of this motorcycle and should remain with it even if the motorcycle is subsequently sold.

-SAFETY WARNINGS: _____

- 1, Traffic regulations vary from state to state. Study the regulations in your state before riding this motorcycle.**
- 2. This motorcycle is designed for on-road use only. It is not suitable for off-road use.**
- 3. GASOLINE IS HIGHLY FLAMMABLE:**
 - * Always turn off the engine when refuelling.**
 - * Take care not to spill any gasoline on the engine or exhaust pipe(s)/muffler(s) when refuelling.**
 - * Never refuel while smoking or in the vicinity of an open flame.**
- 4. If you should swallow some gasoline, or inhale a lot of gasoline vapor, or allow some gasoline to get in your eye(s), see your doctor immediately. If any gasoline spills on your skin or clothing, immediately wash it with soap and water and change your clothes.**

5. **Always turn off the engine before leaving the motorcycle unattended and do not forget to remove the ignition key. When parking the motorcycle, note the following:**
 - * **The engine and exhaust pipe(s)/muffler(s) may be hot. Park the motorcycle in a place where pedestrians or children are not likely to touch the motorcycle.**
 - * **Do not park the motorcycle on a slope or soft ground; the motorcycle may overturn.**
6. **When transporting the motorcycle in another vehicle, be sure it is kept upright and that the fuel petcock(s) is turned to the “ON” or “RES” position (for vacuum type)/“OFF” position (for manual type). If it should lean over, gasoline may leak out of the carburetor or fuel tank.**
7. **Never start your engine or let it run for any length of time in a closed area. The exhaust fumes are poisonous and may cause loss of consciousness and death within a short time. Always operate your motorcycle in an area with adequate ventilation.**
6. **Always wear a helmet, gloves, trousers (tapered around the cuff and ankle so they do not flap), and a brightly colored jacket.**

INTRODUCTION

Congratulations on your purchase of the Yamaha XS850G. This model represents the product of many years of Yamaha experience in the production of fine sporting, touring, and pacesetting racing machines. You can now appreciate the high degree of craftsmanship and reliability that have made Yamaha a leader in these fields.

This manual will provide the owner with a good basic understanding of the operation and basic maintenance of this vehicle. If you have any questions regarding the operation or maintenance of your motorcycle, please consult your Yamaha dealer.

-NOTICE:

Some data in this manual may become outdated due to improvements made to this model in the future. If there is any question concerning this manual, consult your nearby Yamaha dealer.

This Yamaha Motorcycle in its design and manufacture fully complies with the emissions standards for clean air applicable at the date of manufacture. Yamaha has met these standards without reducing the motorcycle's performance or economy of operation. To maintain these high standards, it is important that you and your dealer pay close attention to the recommended maintenance schedules and operating instructions contained within this manual.

SERVICE DEPT.
INTERNATIONAL DIVISION
YAMAHA MOTOR CO., LTD.

CONTENTS

LOCATION OF THE "CAUTION AND SPECIFICATION LABELS"	1
DESCRIPTION	2
MACHINE IDENTIFICATION	3
CONTROL FUNCTIONS	4
PRE-OPERATION CHECKS	15
OPERATION AND IMPORTANT RIDING POINTS	24
PERIODIC MAINTENANCE AND MINOR REPAIR	30
CLEANING AND STORAGE	72
MISCELLANEOUS	75
SPECIFICATIONS	77
WARRANTY INFORMATION	80
MAINTENANCE RECORD	81
WIRING DIAGRAM	83

LOCATION OF THE "CAUTION AND SPECIFICATION LABELS"

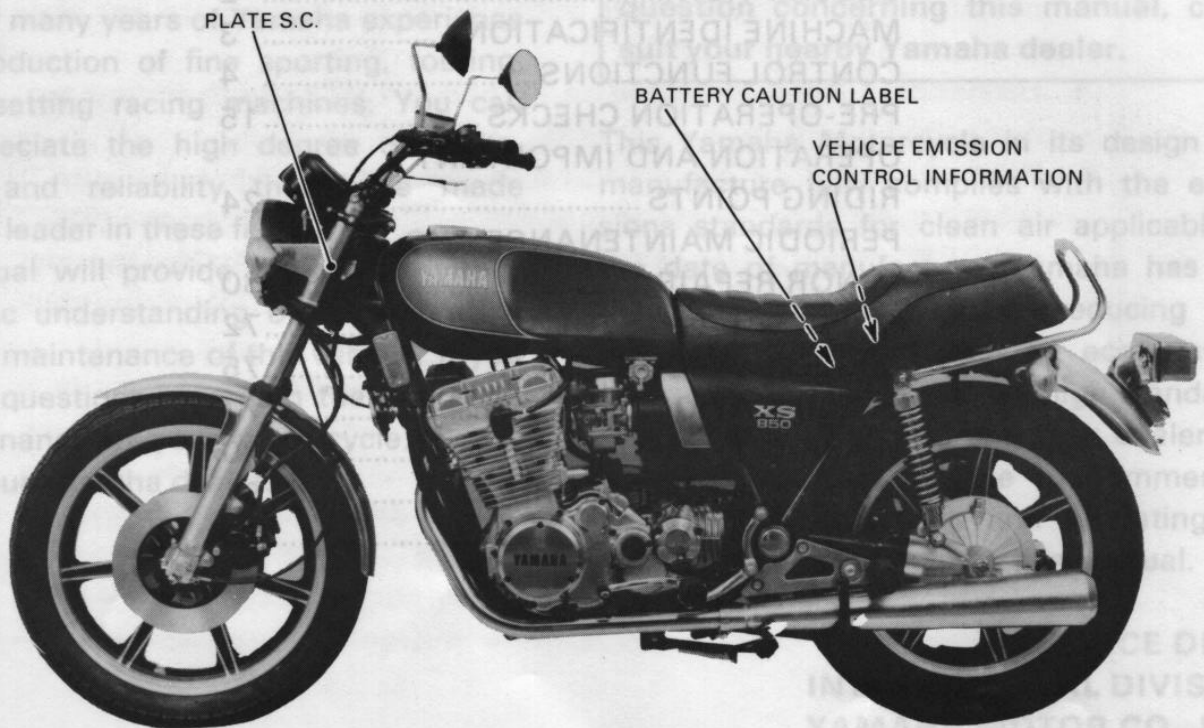

DESCRIPTION

RIGHT SIDE

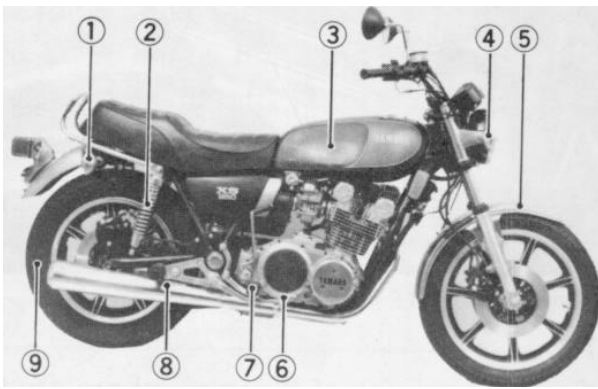

LEFT SIDE

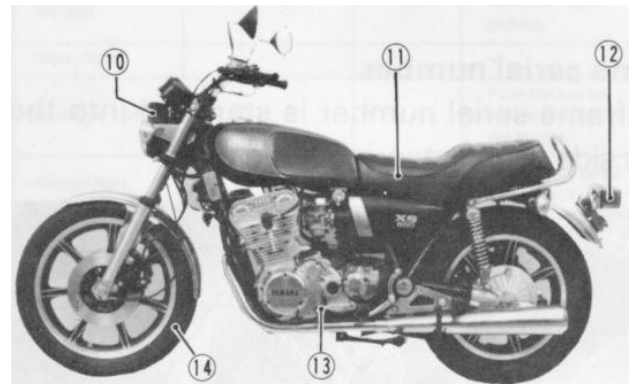

INSTRUMENTS

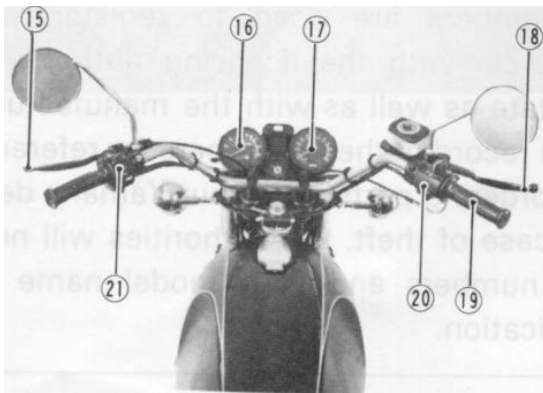

1. Rear flasher light
2. Rear shock absorber
3. Fuel tank
4. Front flasher light
5. Front fender
6. Brake pedal
7. Footrest
8. Silencer
9. Rear wheel
10. Headlight
11. Seat

12. Tail/brake light
13. Change pedal
14. Front wheel
15. Clutch lever
16. Speedometer
17. Tachometer
18. Brake lever
19. Throttle grip
20. Right handlebar switch
21. Left handlebar switch

MACHINE IDENTIFICATION

Frame serial number

The frame serial number is stamped into the right side of the steering head pipe.

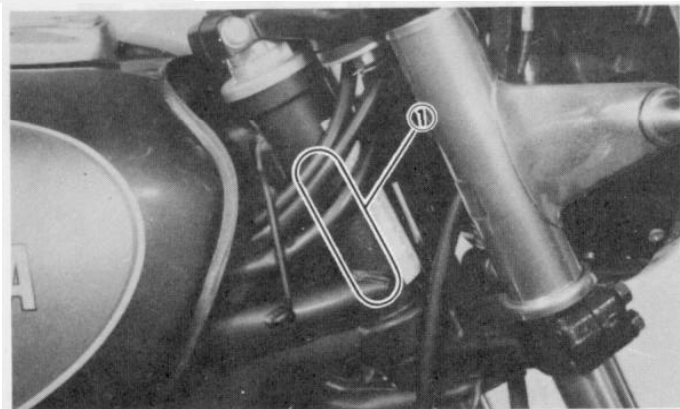

1. Frame serial number

Engine serial number

The engine serial number is stamped into the elevated part of the right rear section of the engine.

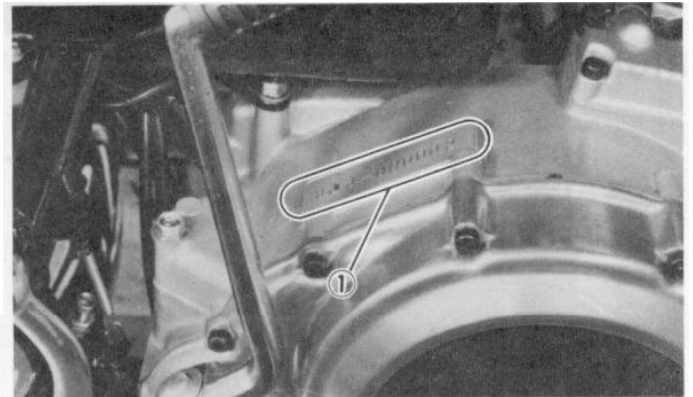

1. Engine serial number

NOTE:

The first three digits of these numbers are for model identification; the remaining digits are the unit production number. These identification numbers are used to register Your motorcycle with the licensing authority in your state as well as with the manufacturer. Keep a record of these numbers for reference when ordering parts from Your Yamaha dealer. In case of theft, the authorities will need these numbers and Your model name for identification.

ON: With the lever in this position fuel flows if the engine is running but stops if the engine is not running.

RES: This indicates "RESERVE". If you run out of fuel while riding, move the lever to "PRI" and switch to "RES" position after starting the engine. Then, fill the tank at the first opportunity.

NOTE: _____

In the "ON" and "RES" positions the petcock works on pressure from the engine turning over. If the line connecting the petcock to the carburetor intake manifold is not connected or has a leak the petcock will not function properly.

PRI: This indicates "PRIME". With the fuel petcock in this position fuel flows whether the engine is running or not. If the fuel tank is completely empty, refill the tank, prime the carburetor in this

position, and then switch to the "ON" position after starting the engine.

Starter (CHOKE)

When cold, the engine requires a richer fuel mixture for starting. A separate starter circuit, which is controlled by the starter, supplies this mixture.

The starter on this model is a 2-position type as follows:

1. Pull the starter fully up.
-When starting a cold engine.
2. Push back the starter half-way.
-When warming up the engine.

NOTE: _____

Refer to "Starting and warming up a cold engine" for proper operation.

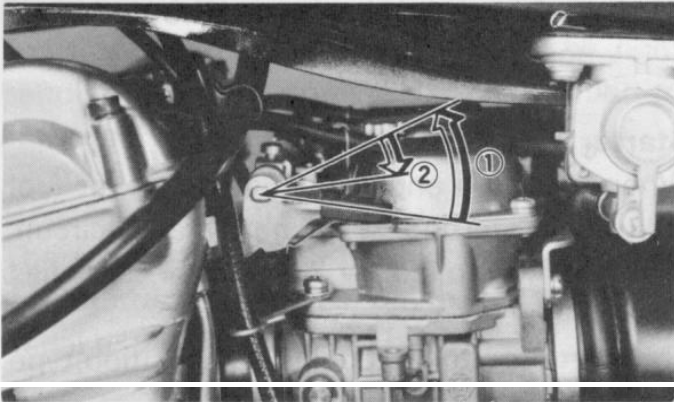

1. Cold engine starting
2. Warming up

Steering lock

To lock the steering, turn the handlebars fully to the right, insert the key into the steering lock and turn the key about 1/8 turn counterclockwise. Then push the key in and turn it about 1/8 turn clockwise. After checking if the lock is engaged, remove the key from the lock. To release the lock, reverse the above steps.

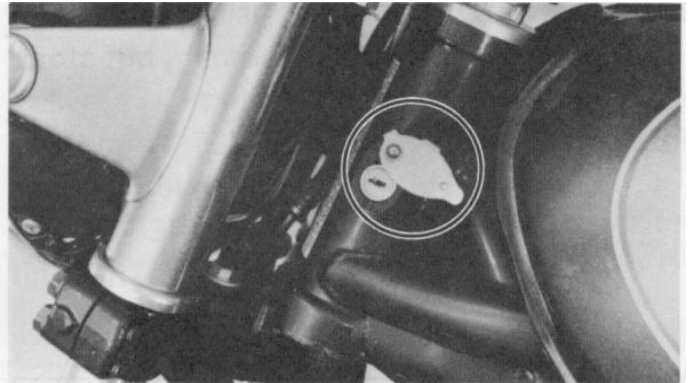

Seat lock

To open the seat lock insert the key in the lock and turn it counterclockwise and pull the lever backwards.

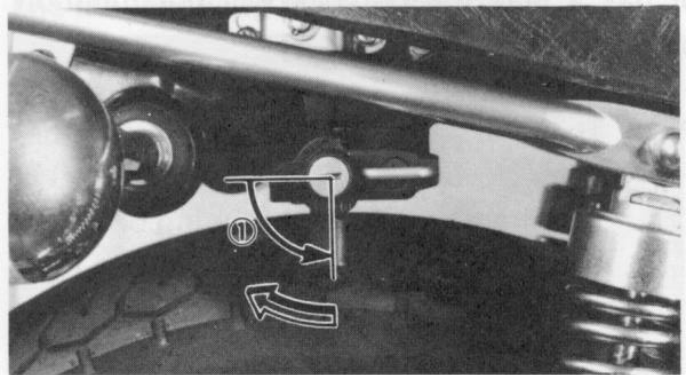

1. Open

In reinstalling the seat, insert the lobes on the seat front into the receptacles on the frame, then push down the seat at the end. After making sure the seat is securely fitted, turn the key clockwise to the center position to lock.

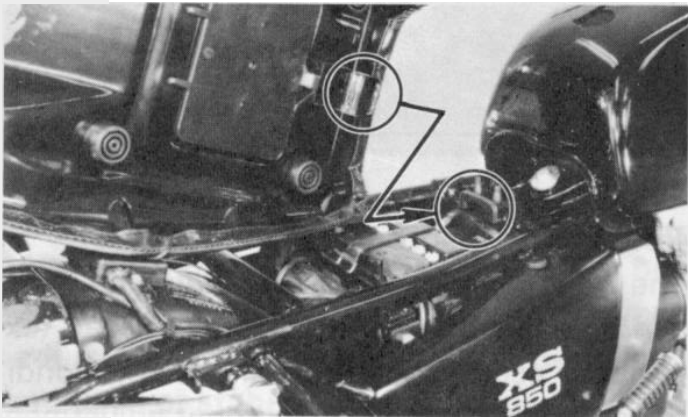

Helmet holder

To open the helmet holder, insert the key in the lock and turn it clockwise.

To lock the helmet holder, replace the holder in the original position.

WARNING:

Never ride with a helmet in the helmet holder. It could interfere with rear wheel movement, causing loss of control and possibly an accident.

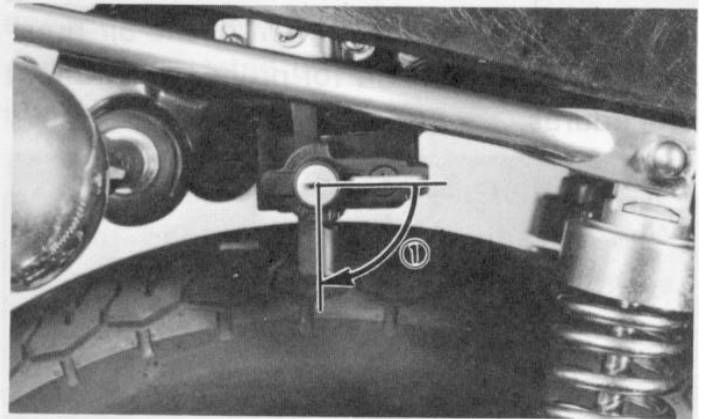

1. Open

Side cover (Left and Right)

To remove the right side cover, pull out the bottom of the cover. To reinstall the cover, make sure the top of the cover is securely seated on the hinge hooks, then push the bottom of the cover into its snap fitting.

Front forks

The front forks of this model are pneumomechanical; namely, a combination air and mechanical coil spring in the inner tube provides suspension best suited to the motorcycle's load (ex: optional accessories etc.) and riding conditions by the adjustment of the air pressure. Refer to page 54 for proper adjustment procedures.

—WARNING:—

Always adjust the fork preload to the same position on each side. Uneven adjustment can cause poor handling and loss of stability.

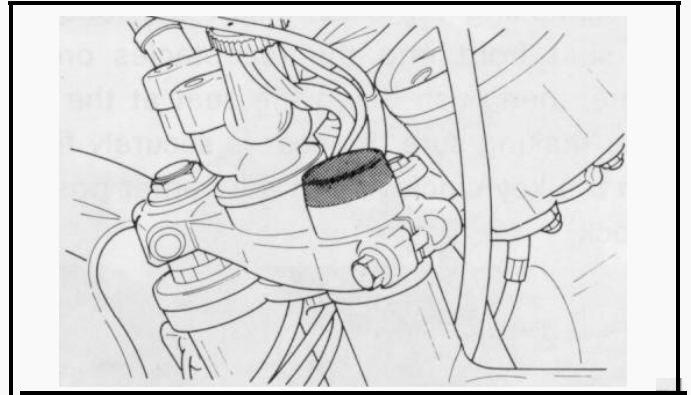

Rear shock absorber

The spring preload and the damping force can be adjusted to suit motorcycle load (ex: optional accessories etc.) and riding conditions. Refer to page 54 for proper adjustment procedures.

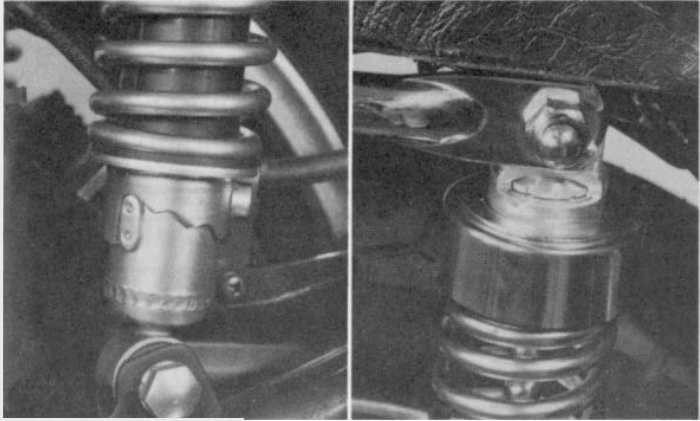

Please ask your nearby Yamaha dealer for further details.

Kick starter

To start the engine, rotate the kick crank, push down lightly with foot until gears engage, and then kick forcefully. This model cannot be started unless the transmission is in neutral.

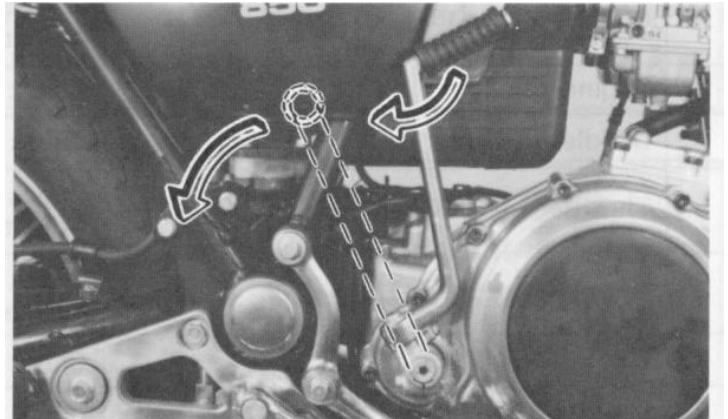

WARNING:

Always adjust the shock absorbers on each side to the same position. Uneven adjustment can cause poor handling and loss of stability.

An optional heavy duty rear shock absorber spring is available for this model.

* **Heavy duty rear shock absorber spring: P/No. 3J2-22212-A0**

PRE-OPERATION CHECKS (DAILY)

Before using this motorcycle check the following points:

No.	Item	Routine	Page
1.	Brakes (Front and Rear)	Check operation, free play and fluid. Top-up with DOT. #3 brake fluid if necessary.	16.44
2.	Clutch	Check operation. condition and free play. Adjust if necessary.	17.49
3.	Engine oil	Check engine oil level. add oil if necessary.	17.38
4	Middle/final Gear Oil	Check for leakage visually.	18.40
5.	Throttle	Check for smooth operation. Adjust if necessary.	17.50
6.	Battery	Check fluid level. top-up with distilled water if necessary.	23.58
7.	Lights/Signals	Check operation.	22
8.	Wheels/Tires	Check tire pressure. wear damage.	18
9.	Fittings/Fasteners	Check all chassis fittings and fasteners. Adjust. if necessary.	37

NOTE:

Pre-operation checks should be made each time the motorcycle is used. Such an inspection can be accomplished in a very short time, and the added safety it assures is more than worth the time involved.

WARNING:

1. The engine, exhaust pipe(s), and muffler(s) will be very hot after the engine has been run. Be careful not to touch them or to allow any clothing item to contact them during inspection or repair.
2. If any item in the PRE-OPERATION CHECK is not working properly, have it inspected and repaired before operating the motorcycle.

Brakes (See page 44 for more detail)

1. Brake lever and brake pedal

Check for correct play in the front brake lever and rear brake pedal. Make sure they are working properly. Check the brakes at low speed shortly after starting out.

- WARNING:

A soft, spongy feeling in the brake lever (and/or brake pedal) indicates a failure in the brake system. Do not operate the motorcycle until the failure in the brake system is corrected. Ask your Yamaha dealer or other qualified mechanic for immediate repairs. A soft, spongy feeling could indicate a hazardous condition in the brake system.

2. Brake fluid

Check the brake fluid level.

Add fluid if necessary

Recommended brake fluid: DOT #3

3. Checking the disc pads

Refer to page 46.

NOTE:

When this brake service is necessary, have your Yamaha dealer or other qualified mechanic replace the pads.

Brake fluid leakage

Apply each brake for a few minutes. Check to see if any brake fluid leaks out from pipe joints or the master cylinder(s).

WARNING:

If brake fluid leakage is found, ask your Yamaha dealer or other qualified mechanic for immediate repairs. Such

leakage could indicate a hazardous condition in the brake system.

Clutch (See page 49 for more detail)

Check for correct play in the clutch lever and make sure the lever operates properly.

If the play is incorrect, make an adjustment,

Throttle grip (See page 50 for more detail)

Turn the throttle grip to see if it operates properly and if the play is normal. Make certain the throttle springs closed when released.

Engine oil (See page 38 for more detail)

Make sure the engine oil is at the specified level. Add oil as necessary.

Recommended oil:

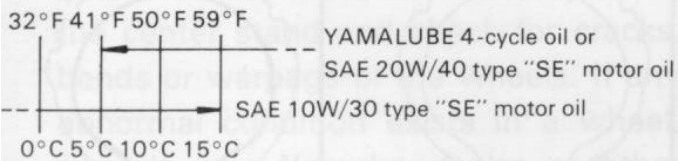

Middle gear/Final gear oil (See page 40 for more detail)

Make sure the middle gear/final gear oil is at the specified level. Add oil as necessary.

Recommended oil:

**SAE 80 or 90 API "GL-4"
Hypoid gear oil**

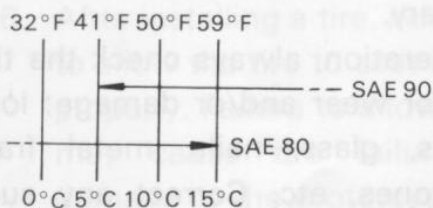

If desired, an SAE 80W/90 hypoid gear oil may be used for all conditions.

NOTE:

"GL-4" is a quality and additive rating. "GL-5" or "GL-6" rated hypoid gear oils may also be used.

TUBELESS TIRES AND ALUMINUM WHEELS

This motorcycle is equipped with aluminum wheels designed to be compatible with either tube or tubeless tires.

Tubeless tires are installed as standard equipment.

WARNING:

Do not attempt to use tubeless tires on a wheel designed for use only with type tires. Tire failure and personal injury may result from sudden deflation.

Tube-type Wheel → Tube-type
Tires Only

Tubeless-type Wheel → Tube-type
or Tubeless tires

WARNING:

**When using tube-type tires, be sure to
install the proper tube also.**

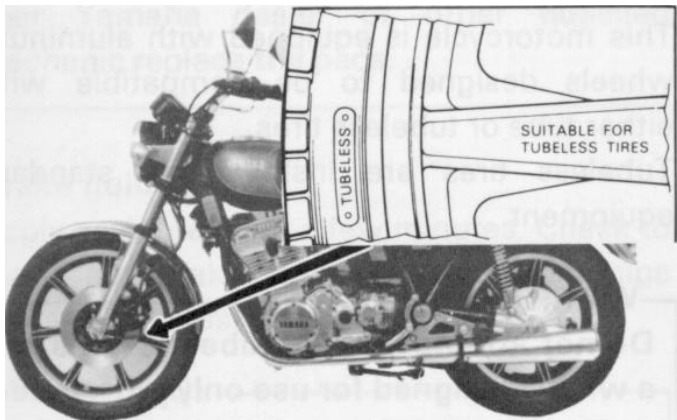
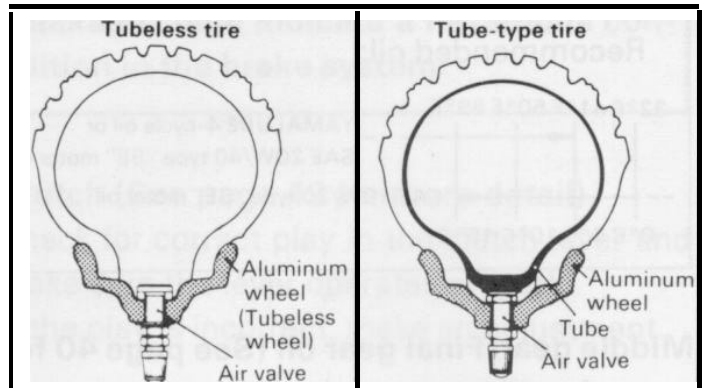

To insure maximum performance, long service, and safe operation, note the following precautions:

1. Always maintain proper air pressure as described in the Chart on page 21.
2. Check tire pressure. before riding. adjust as necessary.
3. Before operation, always check the tire surfaces for wear and/or damage: look for cracks, glass, nails, metal fragments, stones, etc. Correct any such hazard before riding.

4. Always inspect the aluminum wheels before a ride. Place the motorcycle on the center stand and check for cracks, bends or warpage of the wheels. If any abnormal condition exists in a wheel, consult your Yamaha dealer or other qualified mechanic. Do not attempt even small repairs to the wheel. If a wheel is deformed or cracked, it must be replaced.
5. Tires and wheels should be balanced whenever either one is changed or replaced. Failure to have a wheel assembly balanced can result in poor performance, adverse handling characteristics, and shortened tire life.
6. After installing a tire, ride conservatively to allow the tire to seat itself on the rim properly. Failure to allow proper seating may cause tire failure resulting in damage to the motorcycle and injury to the rider.

7. After repairing or replacing a tire, check to be sure the valve stem lock nut is securely fastened. If not, torque it as specified.

Tightening torque: 0.15 m·kg (1.1 ft·lb)
--

The standard equipment tires originally fitted to the _____ are suited to normal riding and touring. They are not suited for sustained high speed running or racing and must not be used for such purposes. Consider your riding skill, road and weather conditions, and correct weight distribution when loading your motorcycle. Securely pack your heaviest items close to the center of the motorcycle.

-WARNING:

- 1. This motorcycle is not designed to pull a trailer or to be attached to a sidecar. The accessories you choose for your motorcycle should be designed specifically for it and should be securely mounted in such a fashion as to maintain the inherent stability of the original design as much as possible. Yamaha has a full line of sport and touring accessories designed specifically for this motorcycle. Please consider them before making a purchase. Use of non-approved accessories may cause loss of handling stability and riding safety. Consult your Yamaha dealer or other qualified mechanic regarding the consequences of using such items.**
- 2. Proper loading of your motorcycle is important for the handling, braking,**

and other performance and safety characteristics of your motorcycle. NEVER OVERLOAD YOUR MOTORCYCLE. Make sure the total weight of the accessories, and etc., does not exceed the maximum load limits. Operation of an overloaded motorcycle could cause tire damage, an accident, and injury.

	FRONT	REAR
XS850G BASIC WEIGHT with oil and full fuel tank	119 kg (262 lb)	139 kg (307 lb)
Standard tire	Bridgestone 3.25H19-4PR	Bridgestone 4.50H17-4PR
Maximum load limit*	170 kg (375 lb)	281 kg (620 lb)
Cold tire pressure Up to 90 kg (198 lb) load**	1.8 kg/cm ² (26 psi)	2.0 kg/cm ² (28 psi)
90 kg (198 lb) load ~ 184 kg (406 lb) load** (Maximum load)	2.0 kg/cm ² (28 psi)	2.3 kg/cm ² (32 psi)
High speed riding	2.0 kg/cm ² (28 psi)	2.3 kg/cm ² (32 psi)
Minimum tire tread	0.8 mm (0.03 in)	0.8 mm (0.03 in)

** Total weight of accessories, etc. excepting motorcycle

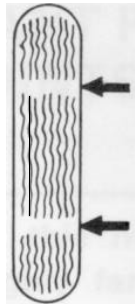

If a tire tread shows crosswise lines, it means that the tire is worn to its limit. Replace the tire.

-WARNING:

It is dangerous to ride with a worn-out tire. When a tire tread begins to show lines. Have Your Yamaha dealer or other qualified mechanic replace the tire immediately. Brake pad replacement, tire, and related wheel parts replacement

should be left to a Yamaha Service Technician or other qualified mechanic. If you must change your own tire, be sure to use proper tools and procedures as described in the Tubeless Tire and Wheel Manual available from Your Yamaha dealer.

Fittings/Fasteners

Always check the tightness of chassis fittings and fasteners before a ride. Use the chart on page 37 to find the correct torque.

Lights and signals

Check the headlight, flasher lights, taillight, brake light, meter lights and all the indicator lights to make sure they are in working condition.

Switches

Check the operation of the headlight switch, turn switch, brake light switch, horn button, main switch, etc.

Battery (See page 58 for more detail)

Check fluid level and top-up if necessary.
Use only distilled water if refilling is necessary.

Fuel

Make sure there is sufficient fuel in the tank.

Recommended gasoline:

Regular gasoline

Fuel tank capacity:

Total: 17 lit. (4.5 US gal.)

Reserve: 3 lit. (0.8 US gal)

OPERATION AND IMPORTANT RIDING POINTS

-CAUTION:

1. Before riding this motorcycle, become thoroughly familiar with all operating controls and their function. Consult your Yamaha dealer or other qualified mechanic regarding any control or function you do not thoroughly understand.
2. Be careful where you store personal items on the motorcycle. Avoid blocking the air cleaner intake or performance will suffer.
3. Be careful not to put anything near the battery and its terminals. Electrical failure and acid corrosion may result.

WARNING:

1. Never start your engine or let it run for any length of time in a closed area. The exhaust fumes are poisonous and can cause loss of consciousness and death within a short time. Always operate your motorcycle in an area with adequate ventilation.
2. Before starting out, always be sure the side stand is up. Failure to retract the side stand completely can result in a serious accident when you try to turn a corner.

Starting and warming up a cold engine

1. Shift transmission into neutral.
2. Turn the fuel petcock to "ON".
3. Turn the ignition key to the "I" position and the engine stop switch to "RUN".

NOTE: _____

At this time the neutral indicator light (green) and the oil pressure indicator light (red) should be on. If the lights do not come on ask your Yamaha dealer to inspect.

4. Operate the starter (CHOKE) by pulling up. Completely close the throttle grip.
5. Start the engine either by pushing the starter button (or by using the kick crank).

NOTE: _____

If the engine fails to start, release the starter button, then push the starter button again. Pause a few seconds before the next attempt. Each cranking should be as short as possible to preserve battery energy. Do not crank the engine more than 10 seconds on each attempt.

If the engine does not start with the starter motor, use the kick starter to start the engine.

CAUTION: _____

The oil pressure indicator light should go off after the engine is started.

If the indicator light flickers or remains on, immediately stop the engine and check the engine oil level and for oil leakage.

If necessary, replenish oil, restart the engine, and check to see that the oil pressure indicator light goes off.

If the light does not go off even with sufficient oil in the crankcase, consult your Yamaha dealer or other qualified mechanic.

6. After starting the engine, push back the starter half-way (warm-up position).

NOTE: _____

To get maximum engine life, always “warm-up” the engine before starting off. Never accelerate hard with a cold engine!

7. After warming up the engine, turn off the starter (push back the starter completely).

NOTE:

To see whether or not the engine is warm, see if engine responds to throttle normally with the starter turned off. To avoid the possibility of excessive exhaust emissions, never leave the starter circuit on longer than necessary.

The length of time the starter is used to start a cold engine depends upon the ambient temperature:

Warm ambient temperatures (above 10°C — 50°F) require about 25 seconds of starter use.

Cold ambient temperatures (below 10°C — 50°F) require about 35 seconds with the starter fully open, then about 2.5 minutes with the starter in the half-open position.

Starting a warm engine

To start a warm engine, the starter (CHOKE) is not required.

CAUTION:

See "Break-in section" prior to operating engine for the first time.

Engine break-in

There is never a more important period in the life of your motorcycle than the period between zero and 1,000 km (600 mi). For this reason we ask that you carefully read the following material. Because the engine is brand new, you must not put an excessive load on it for the first 1,000 km (600 mi). The various parts in the engine wear and polish themselves to the correct operating clearances. During this period prolonged full throttle operation, or any condition which might result in excessive heating of the engine, must be avoided.

- 1 0 ~ 150 km (0 ~ 90 mi):
Avoid operation above 4,000 r/min.
Allow a cooling off period of 5 to 10 minutes after every hour of operation.
Vary the speed of the motorcycle from time to time. Do not operate it at one set throttle position.
- 2 150 ~ 500 km (90 ~ 300 mi):
Avoid prolonged operation above 5,000 r/min. Allow the motorcycle to rev freely through the gears but do not use full throttle at any time.
- 3 500 ~ 1,000 km (300 ~ 600 mi):
Avoid prolonged full throttle operation.
Avoid cruising speeds in excess of 6,000 r/min.
- 4 1,000 km (600 mi) and beyond:
Avoid prolonged full throttle operation.
Avoid engine speeds in excess of 7,000 r/min. Vary speeds occasionally.

CAUTION:

If any engine trouble **should occur during the break-in period, consult your Yamaha dealer immediately or other qualified mechanic.**

After 1,000 km (600 mi) of operation, be sure to replace the engine oil, oil filter element, middle and final gear oil.

Shifting and acceleration

This model has a 5-speed transmission. The transmission allows you to control the amount of power you have available at a given speed or while accelerating, climbing hills, etc. The use of the change pedal is shown in the illustration. (Page 8)

To shift into NEUTRAL, repeatedly depress the change pedal to the end of its travel (you will feel a stop when you are in first gear). then raise it slightly.

To start out and accelerate:

- 1 Pull the clutch lever to disengage the clutch.
- 2 Shift into **FIRST** gear. The green neutral indicator light should go out.
- 3 Open the throttle gradually. and at the same time, release the clutch lever slowly.
- 4 At the recommended shift point speed in the table below, close the throttle, and at the same time, pull in the clutch lever quickly.
- 5 Shift into **SECOND** gear. (Be careful not to shift into neutral.)
- 6 Open the throttle part way and gradually release the clutch lever.
7. To accelerate use the same procedure to shift into the next higher gear according to the Recommended Shift Point Chart below.

To decelerate:

- 1 Apply front and/or rear brakes to slow the motorcycle.
- 2 When the motorcycle reaches 20 km/h (12.5 mi/h), shift to first gear. Any time the engine appears about to stall or runs very roughly, pull in the clutch and use the brakes to stop.
- 3 When motorcycle is almost completely stopped, shift to neutral. The green neutral indicator light should come on.

Recommended Shift Point

	Acceleration shift point km/h(mi/h)	Deceleration shift point km/h(mi/h)
1st → 2nd	23 (14)	20 (12.5)
2nd → 3rd	36 (22)	20 (12.5)
3rd → 4th	50 (31)	20 (12.5)
4th → 5th	60 (37)	20 (12.5)

CAUTION:

1. Do not glide for long periods with the engine off, and do not tow the motorcycle a long distance. Even with gears in neutral, the transmission is only properly lubricated when the engine is running. Inadequate lubrication may damage the transmission.
- 2 Always use the clutch when changing engine, transmission, and driveline are not designed to withstand the shock load of forced shifting and can be damaged by shifting without the clutch.

-WARNING:

Select a parking place where the motorcycle is not apt to fall. Do not park the motorcycle on a slope or soft ground; the motorcycle may overturn.

Parking

When parking, stop the engine and remove the ignition key.

PERIODIC MAINTENANCE AND MINOR REPAIR

Periodic inspection, adjustment and lubrication will keep your motorcycle in the safest and most efficient condition possible. Safety is an obligation of the motorcycle owner.

The most important points of motorcycle inspection, adjustment and lubrication are explained in the following pages.

“Maintenance, replacement, or repair of the emission control devices and systems may be performed by any repair establishment or individual using any part which is certified (if applicable).”

—CAUTION:—

If the owner is not familiar with motorcycle service, this work should be done by a Yamaha dealer or other qualified mechanic.

PERIODIC MAINTENANCE
PROPER PERIODIC MAINTENANCE OF YOUR MOTORCYCLE IS IMPORTANT TO ITS GIVING YOU LONG, PLEASURABLE SERVICE: ESPECIALLY IMPORTANT ARE THE MAINTENANCE SERVICES RELATED TO EMISSIONS CONTROL. THESE CONTROLS NOT ONLY FUNCTION TO ENSURE CLEANER AIR BUT ARE ALSO VITAL TO PROPER ENGINE OPERATION AND MAXIMUM PERFORMANCE. IN THE FOLLOWING TABLES OF PERIODIC MAINTENANCE, THE SERVICES RELATED TO EMISSIONS CONTROL ARE GROUPED SEPARATELY. THESE SERVICES REQUIRE SPECIALIZED DATA, KNOWLEDGE, AND EQUIPMENT. YAMAHA DEALERS ARE TRAINED AND EQUIPPED TO PERFORM THESE PARTICULAR SERVICES.

Tool kit

The service information included in this manual is intended to provide you, the owner, with the necessary information for completing some of your own preventive maintenance and minor repairs. The tools provided in the owner's tool kit are sufficient for most of these purposes. except that a torque wrench is also necessary to properly tighten nuts and bolts.

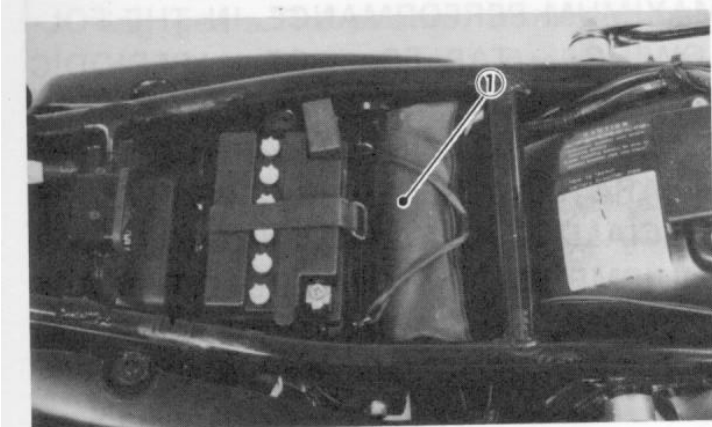

1. Tool kit

NOTE:

If you do not have a torque wrench available during a service operation requiring one, take your motorcycle to a Yamaha dealer or other qualified mechanic to check the torque settings and adjust them as necessary.

-WARNING:

Modifications to this motorcycle not approved by Yamaha may **cause loss of performance, excessive emissions can render it unsafe for use. Consult your Yamaha dealer or other qualified mechanic before attempting any changes.**

PERIODIC MAINTENANCE EMISSION CONTROL SYSTEM

No	Item	Remarks	Initial break-in		Thereafter every	
			1,000 km (600 mi) or 1 month	5,000 km (3,000 mi) or 7 months	4,000 km (2,500 mi) or 6 months	8,000 km (5,000 mi) or 12 months
1*	Cam chain	Check and adjust chain tension,	0	0		0
2*	Valve clearance	Check and adjust valve clearance when engine is cold.		0		0
3	Spark plugs	Check condition. Adjust gap. Clean. Replace after initial 1,300 km (8,000 mi).		0	0	Replace. Every 12,000 km or 18 months (7,500 mi).
4*	Crankcase ventilation system	Check ventilation hose for cracks or damage. Replace if necessary.		0		0
5*	Fuel line	Check fuel hose for cracks or damage. Replace if necessary.		0		0
6*	Exhaust system	Check for leakage. Retighten as necessary. Replace gasket(s) if necessary.		0	0	
7*	Carburetor synchronization	Adjust synchronization of carburetors.		○	○	
8*	Idle speed	Check and adjust engine idle speed. Adjust cable free play if necessary.		0	0	

* It is recommended that these items be serviced by your Yamaha dealer or other qualified mechanic.

Spark plug inspection

The spark plug is an important engine component and is easy to inspect. The condition of the spark plug can indicate something of the condition of the engine.

Normally, all spark plugs from the same engine should have the same color on the white porcelain insulator around the center electrode. The ideal color at this point is a medium to light tan color for a motorcycle that is being ridden normally. If one spark plug shows a distinctly different color, there could be something wrong with the engine. For example, a very white center electrode porcelain color could indicate an intake tract air leak or carburetion problem for that cylinder. Do not attempt to diagnose such problems yourself. Instead, take the motorcycle to your Yamaha dealer or other qualified mechanic.

You should periodically remove and inspect the spark plug because heat and deposits will cause any spark plug to slowly break down

and erode. If electrode erosion becomes excessive, or if carbon and other deposits are excessive, you should replace the spark plug with one of the proper type.

Standard spark plug:

BP7ES (NGK) or N-7Y (CHAMPION)

Before installing any spark plug, measure the electrode gap with a wire thickness gauge and adjust to specifications.

Spark plug gap:

0.7 ~ 0.8 mm (0.028 ~ 0.032 in)

When installing the plug, always clean the gasket surface and use a new gasket. Wipe off any grime from the threads and torque the spark plug properly.

Spark plug torque:

2.0 m-kp (14.5 ft-lb)

NOTE: _____

If a torque wrench is not available when you are installing a spark plug, a good estimate of the correct torque is 1/4 to 1/2 turns past finger tight. Have the spark plug torqued to the correct value as soon as possible with a torque wrench.

GENERAL MAINTENANCE/LUBRICATION

No	Item	Remarks	Type	Initial break-in		Thereafter every		
				1,000 km (600 mi) or 1 month	5,000 km (3,000 mi) or 7 months	4,000 km (2,500 mi) or 6 months	8,000 km (5,000 mi) or 12 months	16,000 km (10,000 mi) or 24 months
1	Engine oil	Warm-up engine before draining	Refer to page 38	0	0	0		
2	Oil filter	Replace	—	0	0		0	
3	gear oil	Replace	Refer to page 40	0			0	
4	Air filter	Dry type filter Clean with compressed air	—		0		0	
5*	Brake system	Adjust free play Replace pads if necessary	—	0	0	0		
6*	Clutch	Adjust free play	—	0	0	0		
7*	Control and meter cable	Apply chain lube thoroughly	Yamaha chain and cable lube or 10W/30 motor oil	0	0	0		
8*	Rear arm pivot bearings	Check bearings assembly for looseness. Moderately repack every 16,000 km (10,000 mi)	Medium weight wheel bearing grease					Repack
9	Brake pedal and change pedal shaft	Apply lightly	Yamaha chain and cable lube or 10W/30 motor oil		0	0		

No.	Item	Remarks	Type	Initial break-in		Thereafter every		
				1,000 km (600 mi) or month	5,000 km (3,000 mi) or 7 months	4,000 km (2,500 mi) or 6 months	8,000 km (5,000 mi) or 12 months	16,000 km (10,000 mi) or 24 months
10	Center and side stand pivots	Apply lightly	Yamaha chain and cable lube or 10W/30 motor oil		0	0		
11*	Front fork oil	Drain completely. Refill to specification	Yamaha fork oil 10Wt or equivalent					0
12*	Steering ball bearing and races	Check bearings assembly for looseness. Moderately repack every 16,000 km (10,000 mi)	Medium weight wheel bearing grease.		0	0		Repack
13*	Wheel bearings	Check bearings for smooth rotation. Replace if necessary	—		0	0		
14	Battery	Check specific gravity. Check breather pipe for proper operation	—		0	0		

- It is recommended that these items be serviced by your Yamaha dealer or other qualified mechanic.

Torque specifications

(For a more complete list, refer to the Service Manual for this model.)

Use a torque wrench to tighten these items. It is recommended that these items should be

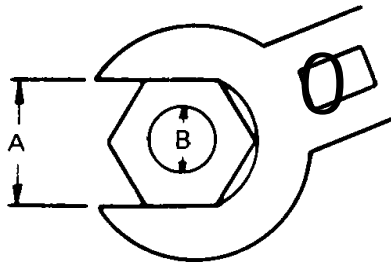

A (Nut)	B (Bolt)	General torque specifications	
		m-kg	ft-lb
10 mm	6 mm	0.6	4.5
12 mm	8 mm	1.5	11
14 mm	10 mm	3.0	22
17 mm	12 mm	5.5	40
19 mm	14 mm	8.5	61
22 mm	16 mm	13.0	94

checked occasionally, especially before a long trip. Always check the tightness of these items whenever they are loosened for any reason.

Item	Torque
Spark plug	2.0 m-kg (14.5 ft-lb)
Engine drain plug	4.3 m-kg (31.0 ft-lb)
Middle drain gear plug	4.3 m-kg (31.0 ft-lb)
Oil filter bolt	3.2 m-kg (23.0 ft-lb)
Change pedal	1.0 m-kg (7.0 ft-lb)
Front engine mount bolts	5.5 m-kg (40.0 ft-lb)
Rear engine mount bolts	2.5 m-kg (18.0 ft-lb)
Steering pinch bolts	1.5 m-kg (11.0 ft-lb)
Shock absorber (top)	3.0 m-kg (21.5 ft-lb)
(bottom)	3.9 m-kg (28.0 ft-lb)
Front wheel axle	10.5 m-kg (76.0 ft-lb)
Front axle holder	2.0 m-kg (14.5 ft-lb)
Rear wheel axle	15.0 m-kg (108.5 ft-lb)
Rear axle pinch bolt	0.6 m-kg (4.5 ft-lb)
Front brake caliper bolt	2.5 m-kg (18.0 ft-lb)
Final gear drain plug	2.3 m-kg (16.5 ft-lb)

Engine oil

1. Oil level measurement

- a. Place the motorcycle on the center stand. Warm up the engine for several minutes.

NOTE: _____

Be sure the motorcycle is positioned straight up when checking the oil level; a slight tilt toward the side can produce false readings.

- b. With the engine stopped, check the oil level through the level window located at the lower part of the right side crankcase cover.

NOTE: _____

Wait a few minutes until the oil level settles before checking.

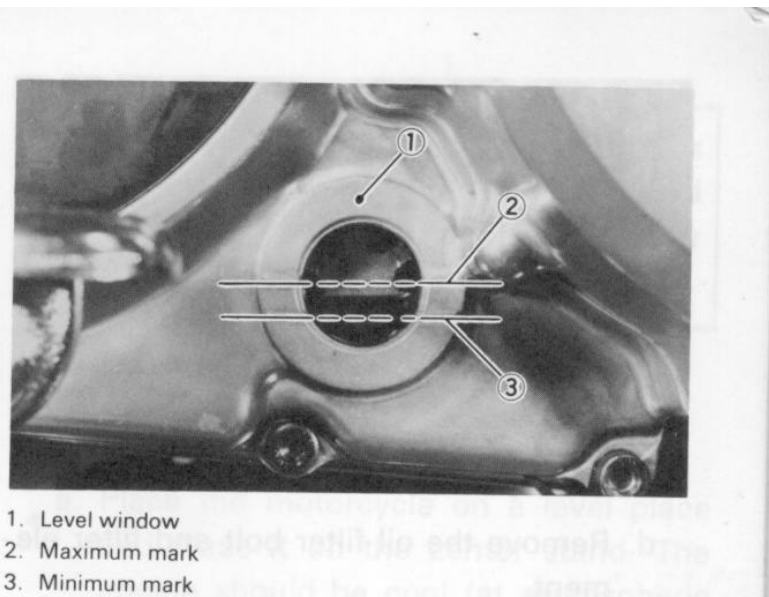

- c. The oil level should be between maximum and minimum marks. If the level is lower, add sufficient oil to raise it to the proper level.

2. Engine oil and oil filter replacement

- a. Start the engine and stop it after a few minutes of warm-up.
- b. Place an oil pan under the engine and remove the oil filler cover.
- c. Remove the drain plug and drain the oil.

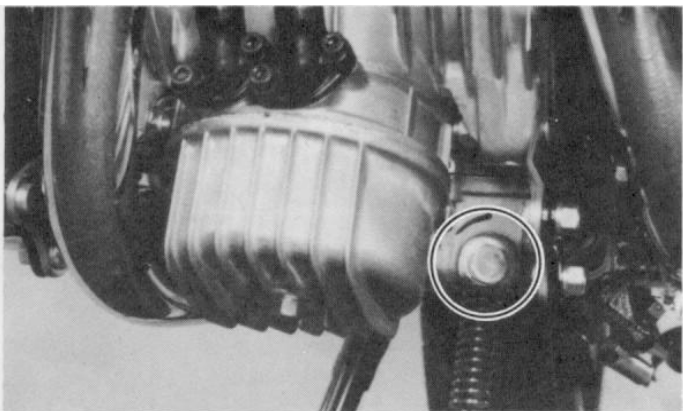

d. Remove the oil filter bolt and filter element.

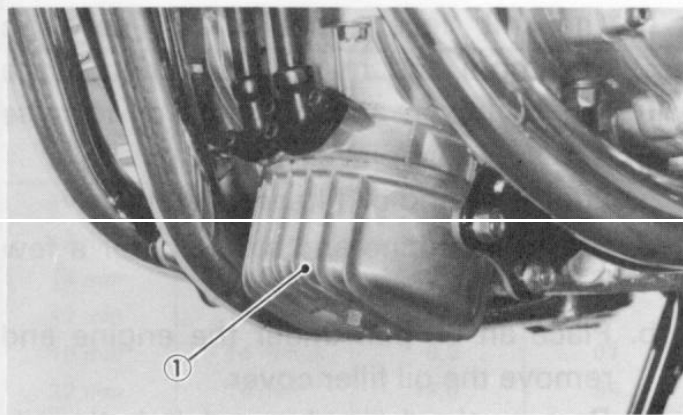

1. Oil filter cover

e. Re-install the drain plug (make sure it is tight).

Drain plug torque: 4.3 m-kg (31 .0 ft-lb)

f. Install the new oil filter element, new "O" ring and filter cover, tighten the oil filter bolt.

Oil filter bolt: 3.2 m-kg (23.0 ft-lb)

NOTE: _____
Make sure the "O" ring is positioned properly.

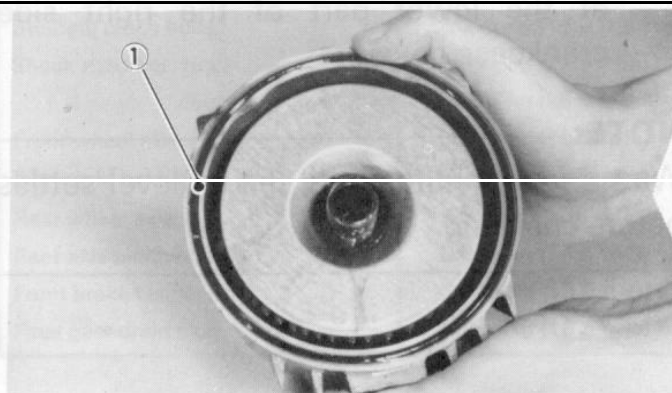

1. Proper O-ring position

g. Add oil through the oil filler hole.

Periodic oil change:

2.8 lit (2.96 US qt)

With oil filter replacement:

3.1 lit (3.28 US qt)

Recommended oil: See page 17.

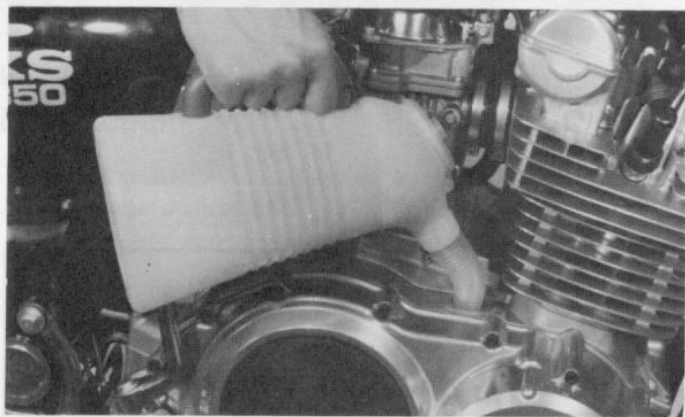

h After replacement of engine oil, and/or oil filter, be sure to check the oil pressure and for any oil leakage. The oil pressure indicator light should go off after the engine is started.

—CAUTION:—

If the indicator light flickers or remains on, immediately stop the engine and consult your Yamaha dealer or other qualified mechanic.

Middle gear/Final gear oil

1. Oil level measurement
 - a. Place the motorcycle on a level place and place it on the center stand. The engine should be cool (at atmospheric temperature).
 - b. Remove the oil filler cap. Check the oil level with level gauge (from tool kit) as shown. The correct oil level is between the two marks on each end of the level gauge. Use the tool end marked "REAR" for measuring the rear (final) gear case. Use the end marked "MIDDLE" for measuring the middle gear case.

NOTE: _____

Middle gear and final gear oil can be checked with same level gauge, which is in the owners tool kit.

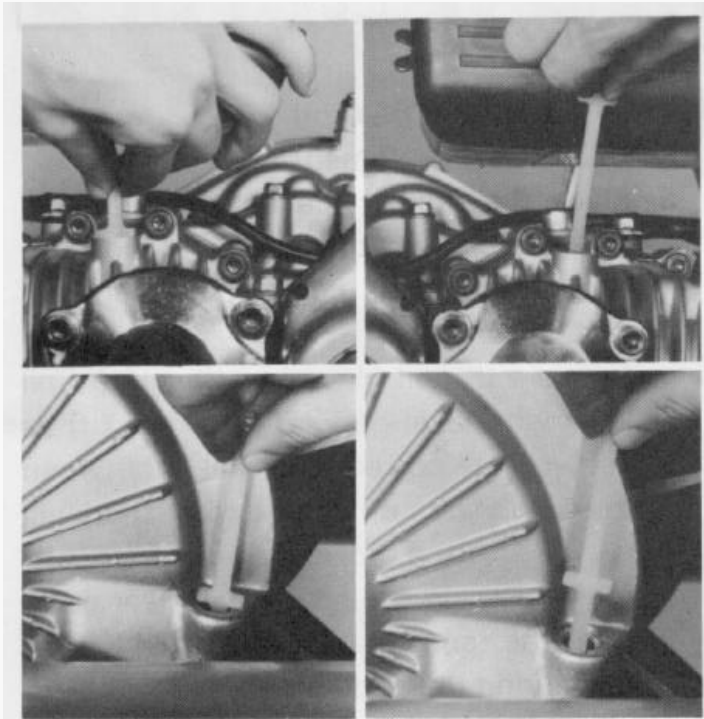

CAUTION: _____

Take care not to allow foreign material to enter the middle and/or final gear case.

2. Gear oil replacement

- a. Place an oil pan under the transmission for the middle gear and under the final gear case.
- b. Remove the middle and/or final gear oil filler cap(s) and the drain plug(s), and drain the oil.

WARNING: _____

When draining or filling, take care not to allow foreign material to enter the middle and/or final gear case. Do not allow the gear oil to contact the tire and wheel.

- c. Reinstall and tighten the middle and/or final gear drain plug(s). (See page 37 for torque specifications.)

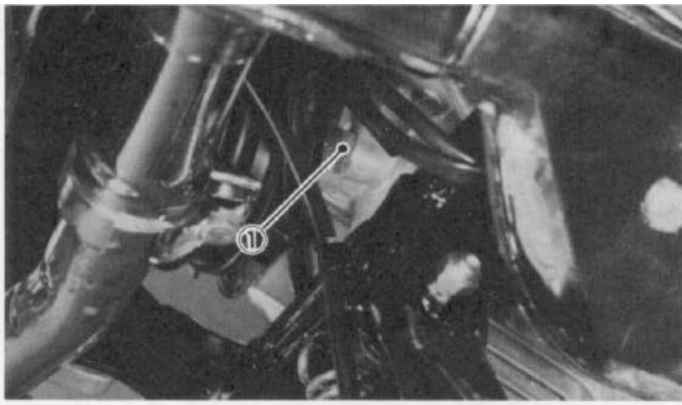

1 Middle gear drain plug

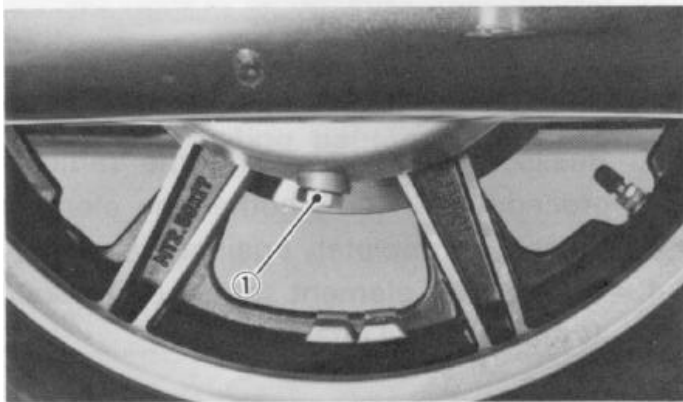

1. Final gear drain plug

- d. Fill the gear case(s) to the specified **level**.

Oil capacity:

Middle gear case:

Approx. 0.375 lit (0.40 US qt)

Final gear case:

Approx. 0.30 lit (0.32 US qt)

Recommended oil: See page 18.

- e. Reinstall the filler cap(s) securely.

Air filter

1. Removal

- a. Remove the air filter case cap by loosening the wing bolt.

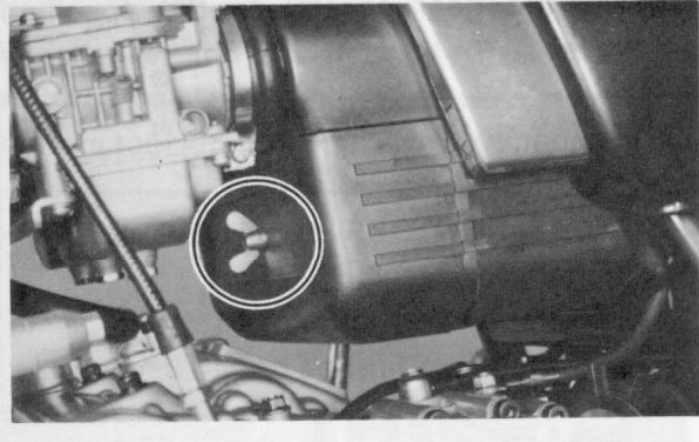

b. Pull out the element.

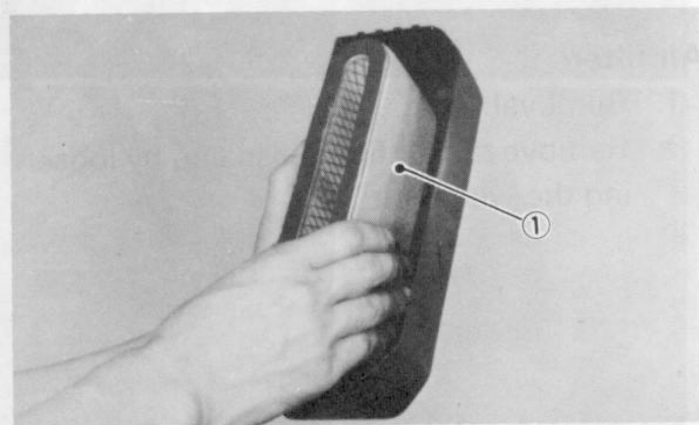

1. Air filter element

2. Cleaning method

Tap the element lightly to remove most of the dust and dirt; then blow out the remaining dirt with compressed air from the inner surface of the element. If element is damaged, replace it.

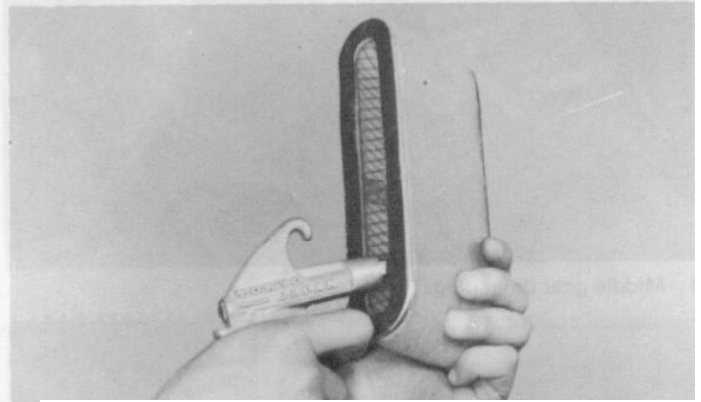

3. Reassemble by reversing the removal procedure. Check whether the element is seated completely against the case.
4. The air filter element should be cleaned at the specified intervals.

-CAUTION:

The engine should never be run without the air cleaner element installed; excessive piston and/or cylinder wear may result.

Front brake adjustment

The front brake lever should be so adjusted that it has a free play of 5 ~ 8 mm (0.2 ~ 0.3 in) at the lever end.

1. Loosen the lock nut on the brake lever.
2. Turn the adjuster so that the brake lever movement at the lever end is 5 ~ 8 mm (0.2 ~ 0.3 in) before the adjuster contacts the master cylinder piston.
3. After adjusting, tighten the lock nut.

NOTE:

Check for correct play and make sure it is working properly.

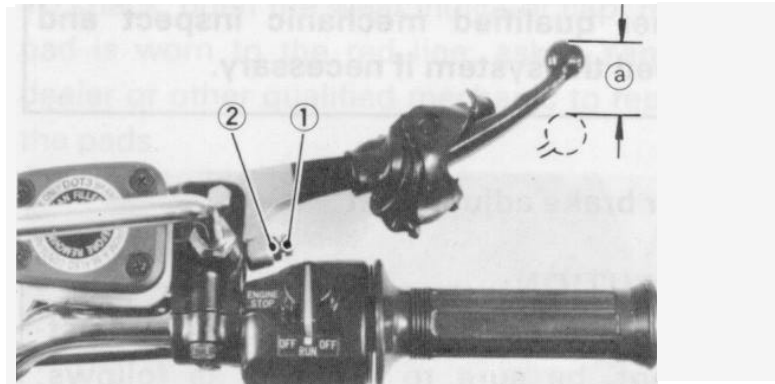

1. Adjuster 2. Lock nut
a. 5 ~ 8 mm (0.2 ~ 0.3 in)

-WARNING:

A soft or spongy feeling in the brake lever (and/or brake pedal) can indicate the presence of air in the brake system. This air must be removed by bleeding the brake system before the motorcycle is operated. Air in the system will result in greatly diminished braking capability and can result in loss of control and an accident. Have your Yamaha dealer or

other qualified mechanic inspect and bleed the system if necessary.

Rear brake adjustment

CAUTION:

For the brake pedal position adjustment, be sure to proceed as follows; (It is advisable to have your Yamaha dealer or other qualified mechanic make this adjustment.)

The rear brake pedal should be so adjusted that it has a free play of 13~ 15 mm (0.51-0.59 in) from when the brake pedal is stepped on to when the brake begins to engage.

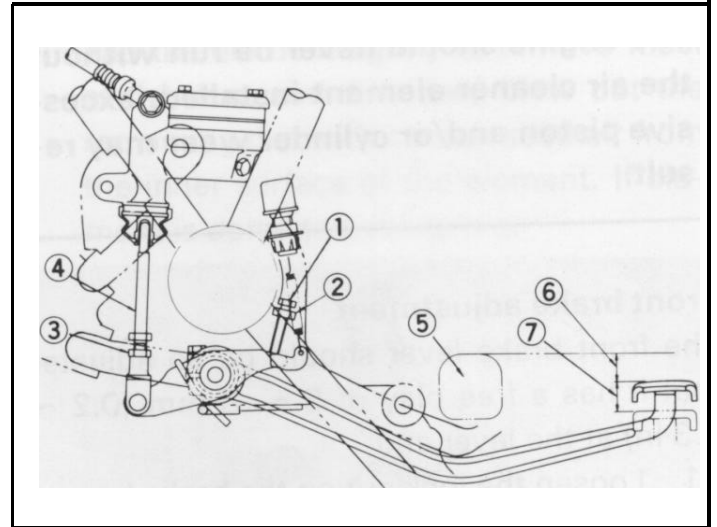

- | | |
|-------------------------------------|--|
| 1. Adjuster bolt (for pedal height) | 5. Footrest |
| 2. Locknut | 6. Pedal height 20 mm (0.78 in) |
| 3. Locknut | 7. Free play 13~15mm
(0.51-0.59 in) |
| 4. Brake rod | |

1. Loosen the adjuster lock nut (for pedal height).
2. By turning the adjuster bolt clockwise or counterclockwise, adjust the brake pedal position so that its top end is approx. 20 mm (0.78 in) below the footrest top end.

3. **Secure the adjuster lock nut.**
4. Loosen the brake rod downward until there is noticeable free play between rod and master cylinder.
5. Turn in the brake rod until it lightly touches the master cylinder, then turn it out by approx. 1 and 3/4 turns (for proper free play).
6. Tighten the brake rod adjuster lock nut.

-CAUTION:

See that the punched mark on the brake rod is not above the top surface of the adjuster lock nut in securing the brake rod adjuster lock nut.

Checking the front and rear brake pads

In order to check wear on the disc brake pads, a wear indicator is attached to each brake pad.

This indicator permits a visual check without disassembling the pads.

To check, open the wear indicator cap. If any pad is worn to the red line, ask a Yamaha dealer or other qualified mechanic to replace the pads.

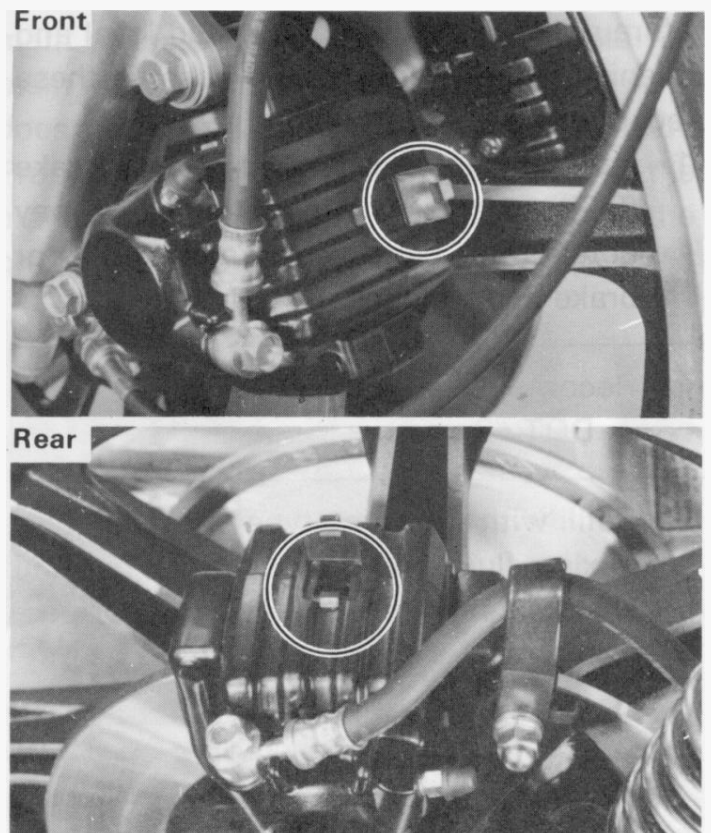

Inspecting the brake fluid level

Insufficient brake fluid may allow air to enter the 'brake system, possibly causing the brakes to become ineffective.

Before riding, check the brake fluid level and replenish when necessary. and observe these precautions:

- 1, Use only the designated quality brake fluid; otherwise, the rubber seals may deteriorate, causing leakage and poor brake performance.

**Recommended brake fluids:
DOT #3**

2. Refill with the same type of brake fluid; mixing fluids may result in a harmful chemical reaction and lead to poor performance.

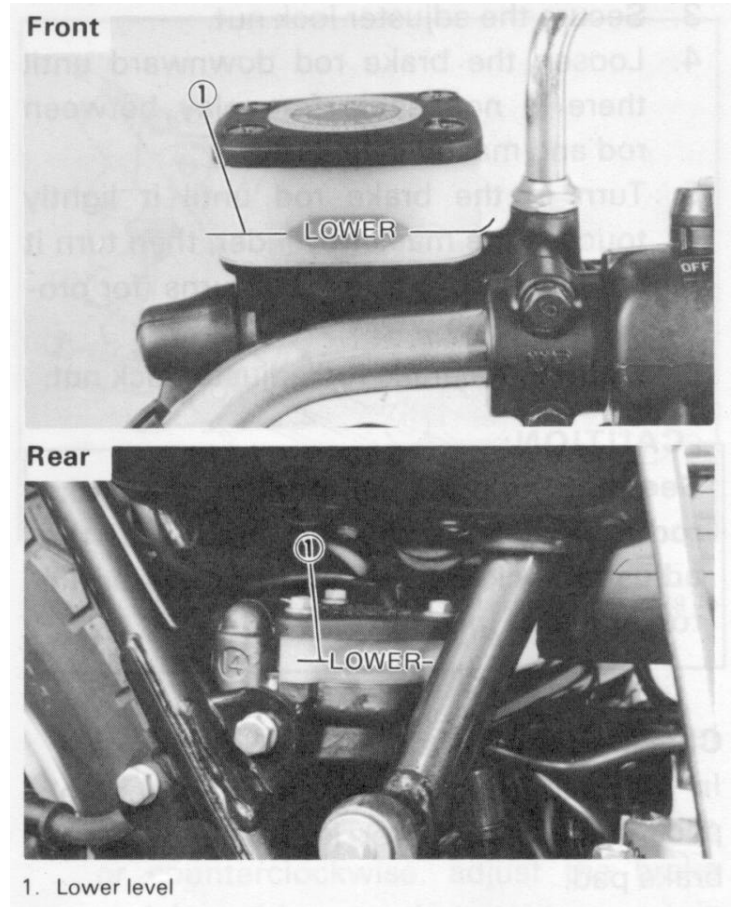

3. Be careful that water does not enter the master cylinder when refilling. Water will significantly lower the boiling point and may result in vapor lock.
4. Brake fluid may erode painted surfaces or plastic parts. Always clean up spilled fluid immediately.
5. Have a Yamaha dealer or other qualified mechanic check the cause if the brake fluid level goes down.

Brake fluid replacement

1. Complete fluid replacement should be done only by trained Yamaha service personnel or other qualified mechanic.
2. Complete fluid replacement should be done whenever the caliper cylinder or master cylinder is disassembled, or the fluid becomes seriously contaminated.
3. Replace the following components whenever damaged or leaking. Also:
 - a. Replace all brake seals every two years.

- b. Replace all brake hoses every four years.

Brake light switch adjustment

The brake light switch is operated by movement of the brake pedal. To adjust, hold the main body of the switch with the hand so it does not rotate and turn the adjusting nut. Proper adjustment is achieved when the brake light comes on slightly before the brake begins to take effect.

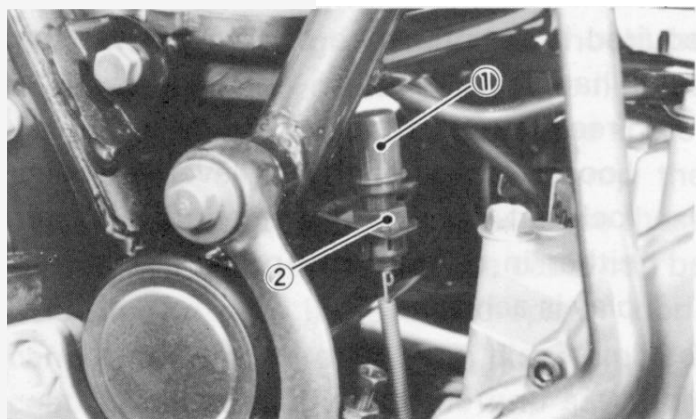

1. Main body 2. Adjusting nut

Clutch adjustment

This model has a clutch cable length adjuster and a clutch mechanism adjuster. The cable length adjuster is used to take up slack from cable stretch and to provide sufficient free play for proper clutch operation under various operating conditions. The clutch mechanism adjuster is used to provide the correct amount of clutch "throw" for proper disengagement. Normally, once the mechanism is properly adjusted, the only adjustment required is maintenance of free play at the clutch handlebar lever.

1. Free play adjustment

Loosen the handlebar lever adjuster lock nut, Next turn the length adjuster either in or out until proper lever free play is achieved.

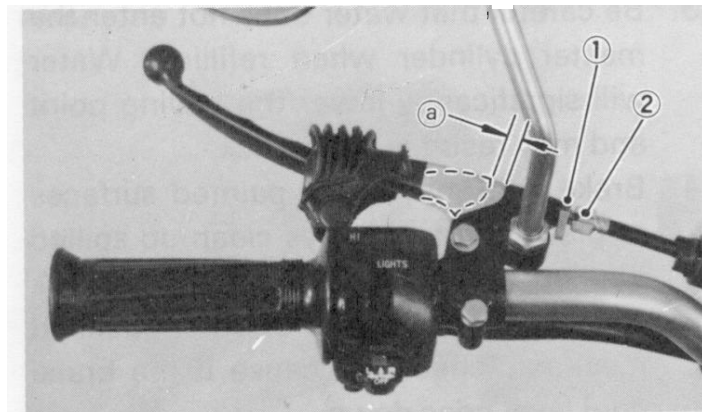

- 1. Locknut
- 2. Adjuster
- a. 2- 3 mm (0.08 ~ 0.12 in)

2. Mechanism adjustment

The second adjustment is located behind the adjusting cover. Removing the cover will expose the adjuster and lock nut.

Loosen the lock nut, rotate the adjuster in until it lightly seats against the clutch push rod that works with the adjuster to operate the clutch. Back the adjuster out 1/4 turn and tighten the lock nut.

This adjustment must be checked because heat and clutch wear will affect this free play, possibly enough to cause incomplete clutch operation. Recheck clutch cable adjustment at the handlebar after adjusting.

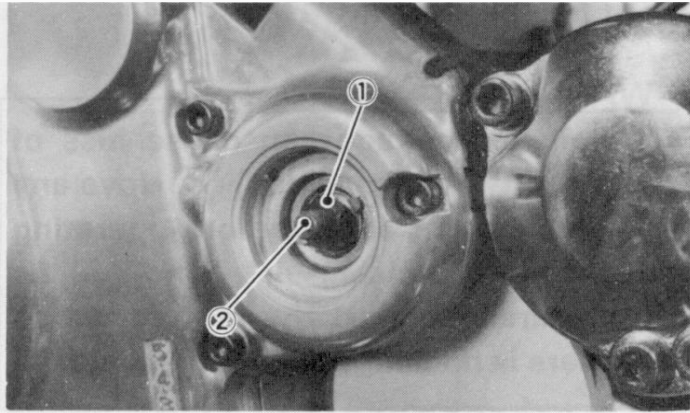

1. Lock nut 2. Adjuster

Cable inspection and lubrication

1. Damage to the outer housing of the various cables may cause corrosion. Often free movement will be obstruct-

ed. An unsafe condition may result, so replace such cables as soon as possible.

2. If the inner cables do not operate smoothly, lubricate or replace them.

Recommended lubricant:

Yamaha chain and cable lube or
10W/30 motor oil

Throttle cable and grip lubrication

The throttle twist grip assembly should be greased when the cable is lubricated, since the grip must be removed to get at the end of the throttle cable. Two screws clamp the throttle housing to the handlebar. Once these two are removed, the end of the cable can be held high to pour in several drops of lubricant. With the throttle grip disassembled, coat the metal surface of the grip assembly with a suitable all-purpose grease to cut down friction.

Rear arm pivot bearings

The swing arm must pivot freely on its bearings but not have any excess play. Have your Yamaha dealer or other qualified mechanic check rear arm pivot bearing operation according to the General Maintenance Schedule.

Brake and change pedal/Brake and clutch lever

Lubricate the pivoting parts of each lever and pedal.

Recommended lubricant:

Yamaha chain and cable lube or
10W/30 motor oil

Center and side stand pivots

Lubricate the center and side stands at their pivot points.

Recommended lubricants:
Yamaha chain and cable lube or
10W/30 motor oil

Front fork oil change

--WARNING:

1. Fork oil leakage can cause loss of stability and safe handling. Have any problem corrected before operating the motorcycle.
2. Securely support the motorcycle so there is no danger of it falling over.

1. Raise the motorcycle or remove the front wheel so that there is no weight on the front end of the motorcycle.
Remove the handlebar.
2. Remove the rubber cap from the top of each fork.

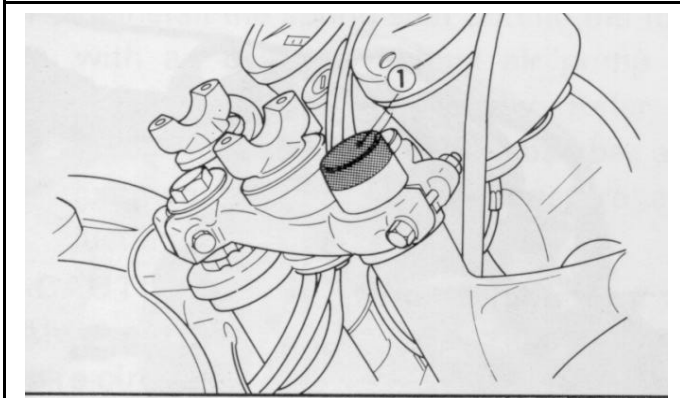

1. Rubbercap

3. **Keep the** valve open while pressing it for several seconds so that the air can be let out of the inner tube.

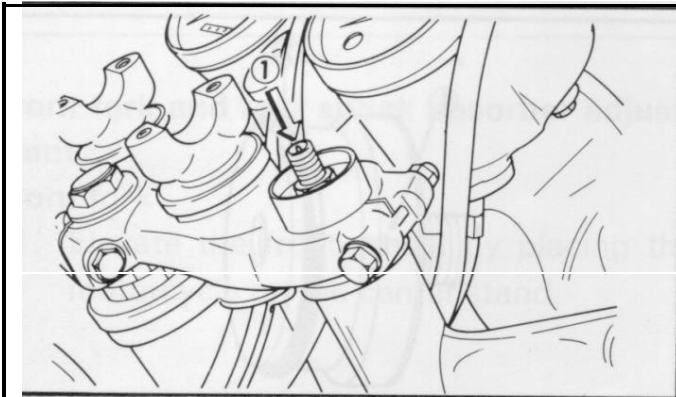

1. Push

4. The spring seat and fork spring are retained by a stopper ring (spring wire circlip). It is necessary to depress the spring seat and fork spring to remove the stopper ring. Remove the stopper ring by carefully prying out one end with a small screwdriver.
5. Place an open container under each drain hole. Remove the drain screw from each outer tube.

-WARNING:

Do not allow oil to contact the disc brake components. If any oil should contact the brake components it must be removed before the motorcycle is operated. Oil will cause diminished braking capacity and will damage the rubber components of the brake assembly.

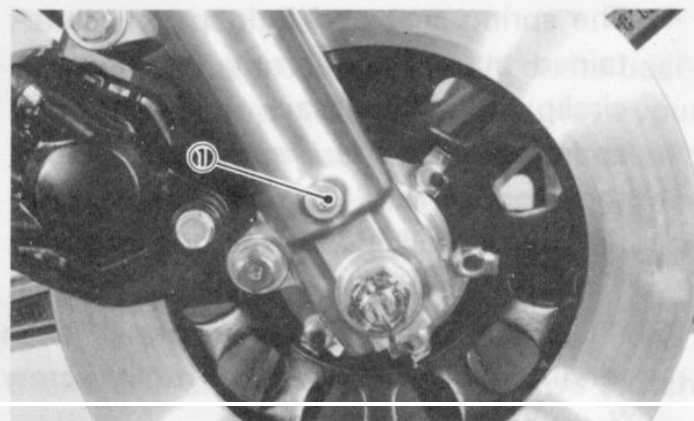

1. Drain screw

6. When most of the oil has drained, slowly raise and lower the outer tubes to pump out the remaining oil.
7. Inspect the drain screw gasket. Replace if damaged. Reinstall the drain screw.
8. Pour the specified amount of oil into the fork inner tube.

Front fork oil (each fork):

195 cc (6.60 oz)

Yamaha Fork Oil 10 wt or equivalent

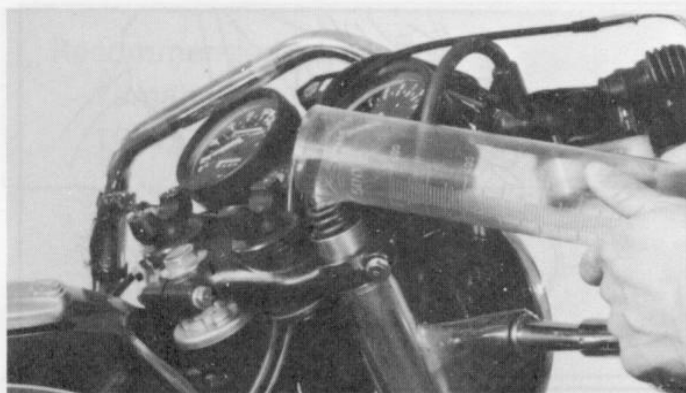

9. After filling, slowly pump the forks up and down to distribute the oil.
10. Inspect the "O-ring" on the spring seat. Replace "O-ring" if damaged.

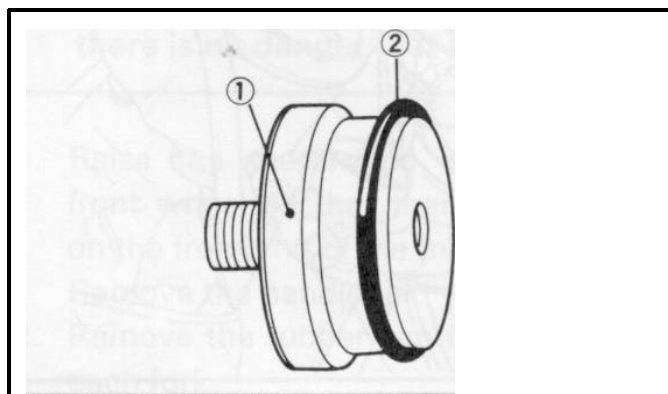

1. Spring seat 2. O-ring

11. Reinstall the spring seat and fill the fork with air using a manual air pump or other pressurized air supply. Refer to "Front fork and rear shock absorber adjustment" for proper air pressure adjusting.

CAUTION:

Always use a new stopper ring (spring wire circlip).

Maximum air pressure:

2.5 kg/cm² (36 psi)

Do not exceed this amount

Front fork and rear shock absorber adjustment

Front fork:

1. Elevate the front wheel by placing the motorcycle on the center stand.

NOTE: _____
When checking and adjusting the air pressure, there should be no weight on the front end of the motorcycle.

2. Remove the rubber cap from the top of each fork.

3. Using the air gauge, check and adjust the air pressure.

If the air pressure is increased, the suspension becomes stiffer and if decreased, it becomes softer.

To increase:

Use a manual air pump or other pressurized air supply.

To decrease:

Release the air by pushing the valve pin.

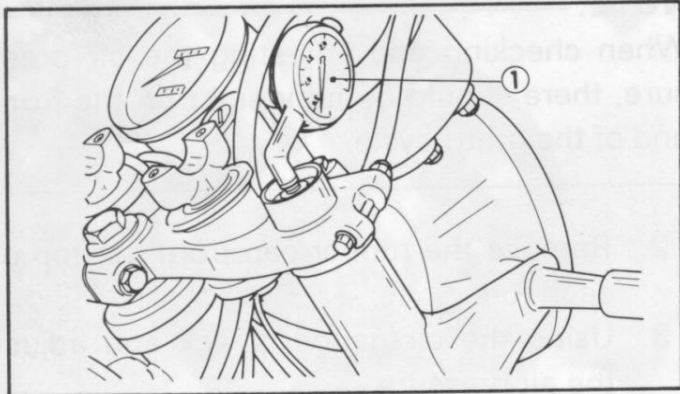

1. Air gauge

Standard air pressure:

0.4 kg/cm² (5.7 psi)

Maximum air pressure:

2.5 kg/cm² (36 psi)

Minimum air pressure: Zero

- * Never exceed the maximum pressure, or oil seal damage may occur.
- * The difference between both the left and right tubes should be 0.1 kg/cm² (1.4 psi) or less.

4. Install the rubber caps securely.

Rear shock absorber:

1, Spring preload

If the spring seat is raised, the spring becomes stiffer and if lowered, it becomes softer.

Standard position — A

A. position — Softest

E. position — Stiffest

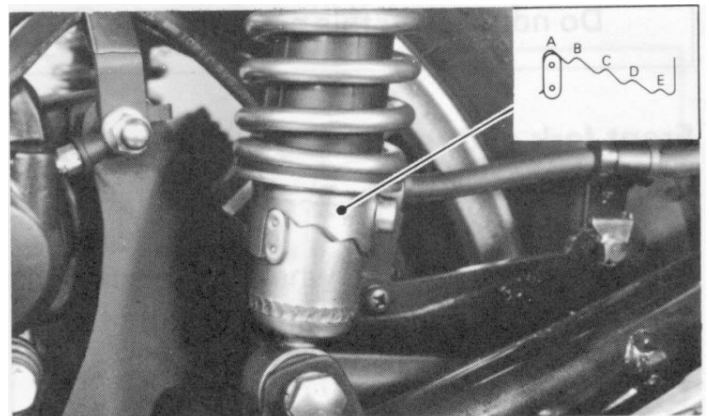

2. Damping force

Turn the damping force adjuster with your fingers to increase or decrease the damping force. If it is difficult to turn it with your fingers, use a screw driver.

Standard position — No. 1

No. 1 — Minimum damping force

No. 4 — Maximum damping force

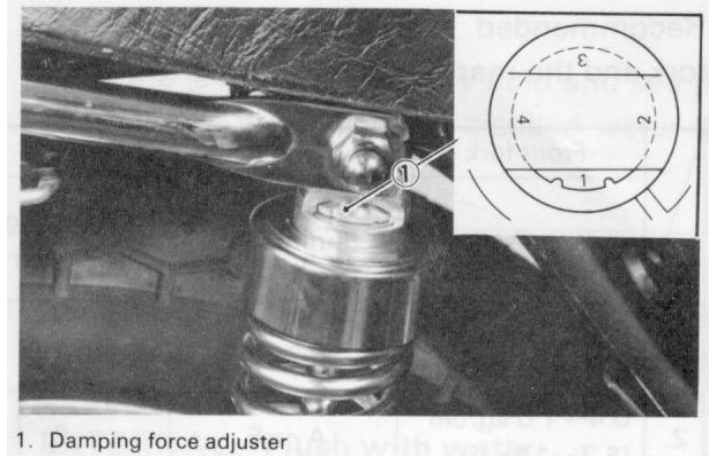

NOTE: _____

When adjusting the damping force, the adjuster should be placed in the clicked position. If not, the damping force will be set to the maximum (No. 4).

Always adjust both the right and left absorbers to the same position.

Recommended combinations of the front fork and the rear shock absorber.

Use this table as guidance to meet specific riding conditions and motorcycle load.

	Front fork	Rear shock absorber		Loading condition		
	Air pressure	Spring seat	Damping adjuster	Solo rider	With passenger	With accessory equipments and/or passenger
1.	0.4~1.0 kg/cm ² (5.7~14 psi)	A ~ E	1	○		
2.	0.4~1.0 kg/cm ² (5.7~14 psi)	A ~ E	2	○	○	
3.	1.0~1.5 kg/cm ² (14~21 psi)	C ~ E	3		○	○
4.	1.5 kg/cm ² (21 psi)	E	4			○

Steering inspection

Periodically inspect the condition of the steering. Worn out or loose steering bearings may be dangerous.

Place a block under the engine to raise the front wheel of the motorcycle off the ground: then hold the lower end of the front fork and

try to move it forward and backward. If any free play can be felt, ask a Yamaha dealer or other qualified mechanic to inspect and adjust the steering assembly.

Inspection is easier if the front wheel is removed.

—WARNING:

Securely support the motorcycle so there is no danger of it falling over.

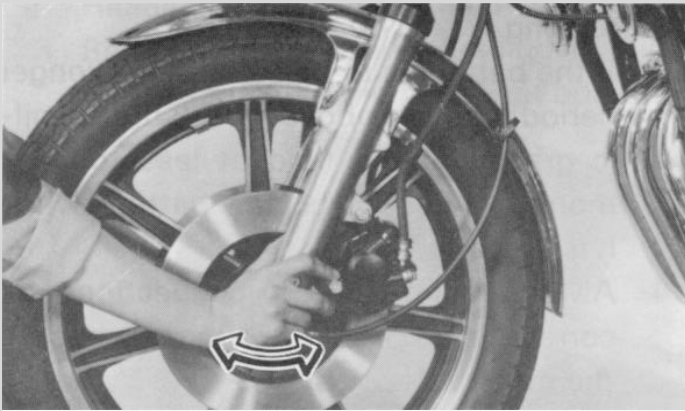

Wheel bearings

If the wheel bearings in the front or rear wheel allow play in the wheel hub, or if the wheel does not turn smoothly, have your Yamaha dealer or a qualified mechanic inspect the wheel bearings. The wheel bearings should be inspected according to the General Maintenance Schedule.

Battery

Check the level of the battery fluid and see if the terminals are tight. Add distilled water if the fluid level is low.

—WARNING:

Battery electrolyte is poisonous and dangerous, causing severe burns, etc. Contains sulfuric acid. Avoid contact with skin, eyes or clothing. Antidote: EXTERNAL-Flush with water.

INTERNAL-Drink large quantities of water or milk. Follow with milk of magnesia, beaten egg or vegetable oil. Call physician immediately.

Eyes: Flush with water for 15 minutes and get prompt medical attention. Batteries produce explosive gases. Keep sparks, flame, cigarettes, etc. away. Ventilate when charging or using in closed space. Always shield eyes when working near batteries. **KEEP OUT OF REACH OF CHILDREN.**

Replenishing the battery fluid

A poorly maintained battery will deteriorate quickly. The battery fluid should be checked at least once a month.

1. The level should be between the upper and lower level marks. Use only distilled water if refilling is necessary.

NOTE: _____
Normal tap water contains minerals which are harmful to a battery; therefore, refill only with distilled water.

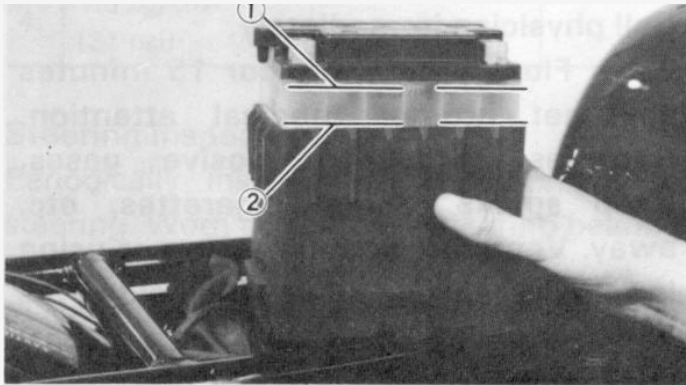

1. Upper level 2. Lower level

2. When the motorcycle is not to be used for a month or longer, remove the battery and store it in a cool, dark place. Completely recharge the battery before reusing.
3. If the battery is to be stored for a longer period than the above, check the specific gravity of the fluid at least once a month and recharge the battery when it is too low.
4. Always make sure the connections are correct when putting the battery back in the motorcycle.

Make sure the breather pipe is properly connected and is not damaged or obstructed.

Headlight

This motorcycle is equipped with a quartz bulb headlight. If the headlight bulb burns out, replace the bulb as follows:

1. Headlight bulb replacement
 - a. Remove the 2 screws holding the light unit assembly to the headlight body.

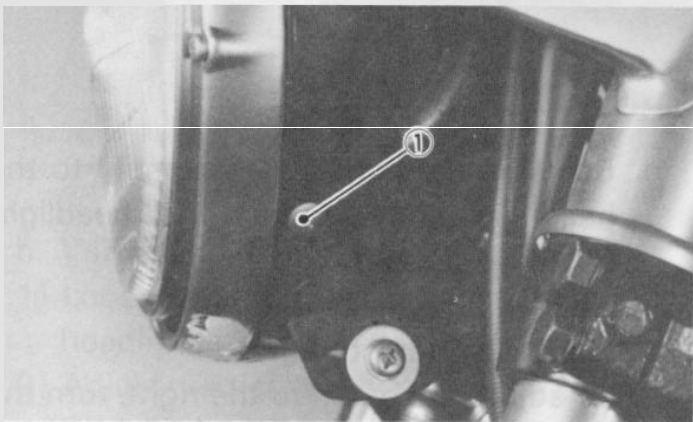

1. Holding screw

- b. Disconnect the lead wires and remove the light unit assembly.

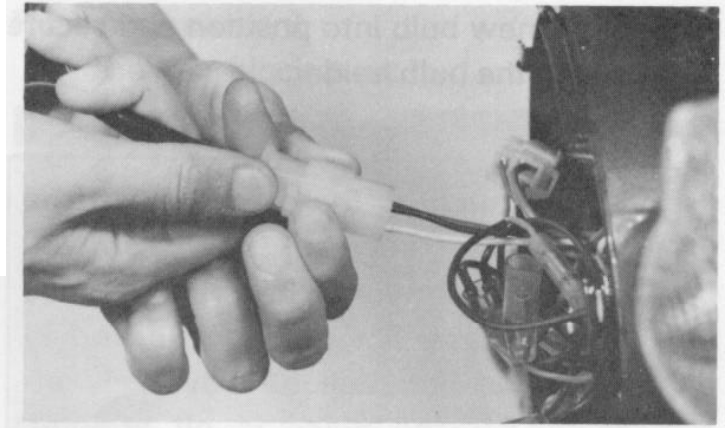

- c. Turn the bulb holder counterclockwise and remove the defective bulb.

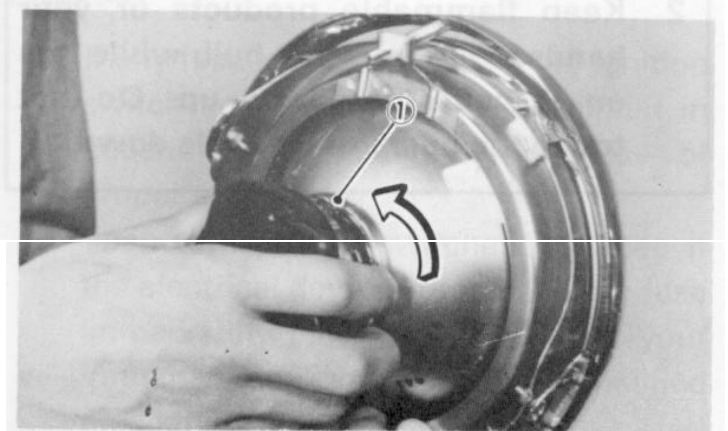

1. Bulb holder

- d. Slip a new bulb into position and secure it with the bulb holder

-CAUTION:

1. Avoid touching the glass part of the bulb. Also keep it free from oil stains; otherwise, the transparency of the glass, life of the bulb and illuminous flux will be adversely affected. If the glass is oil stained, thoroughly clean it with a cloth moistened with alcohol or lacquer thinner.
2. Keep flammable products or your hands away from the bulb while it is on. because it heats up. Do not touch the bulb until it cools down.

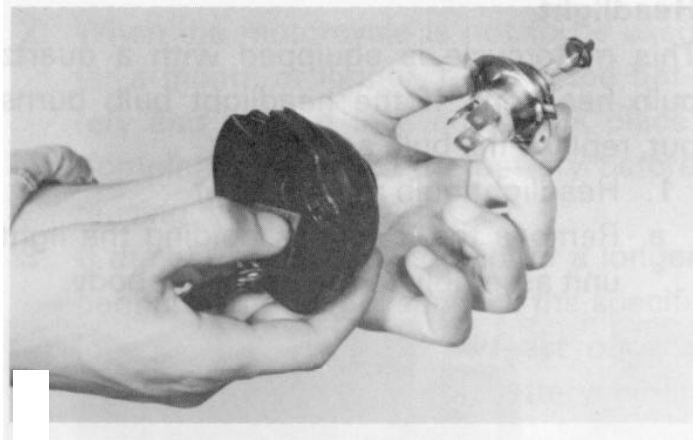

- e Reinstall the light unit assembly to the headlight body. Adjust the headlight beam if necessary.
2. Headlight beam adjustment
 - a Horizontal adjustment:
To adjust the beam to the right, turn the adjusting screw clockwise.
To adjust the beam to the left, turn the screw counterclockwise.



a. Horizontal adjusting screw
b. Vertical adjusting screw

b. Vertical adjustment:

- 1) Loosen the adjusting screw under the headlight body.
- 2) Adjust vertically by moving the headlight body. When proper adjustment is determined, retighten the adjusting screw.

Fuse replacement

1. The fuse block is located under the seat.

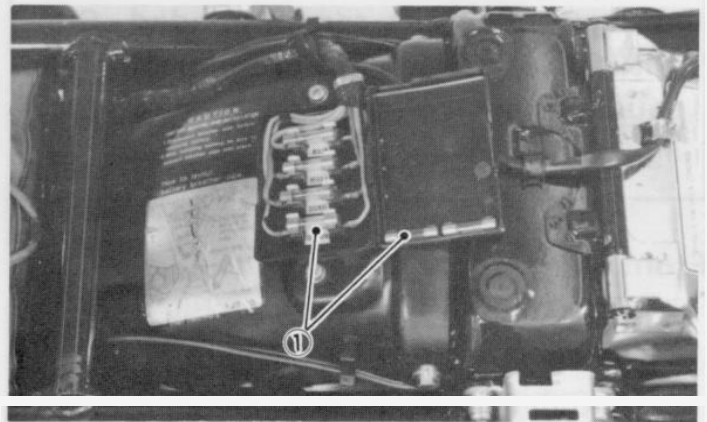

1. Fuse block

2. If any fuse is blown, turn off the ignition switch and the switch in the circuit in question and install a new fuse of proper amperage. Then turn on the switches, and see if the electrical device operates. If the fuse immediately blows again, consult your Yamaha dealer or other qualified mechanic.

-WARNING: _____

Do not use fuses of a higher amperage rating than those recommended. Substitution of a fuse of improper rating can cause extensive electrical system damage and possible fire.

Front wheel removal

1. Place the motorcycle on the center stand.
2. Remove the front fender securing bolts and remove the fender.

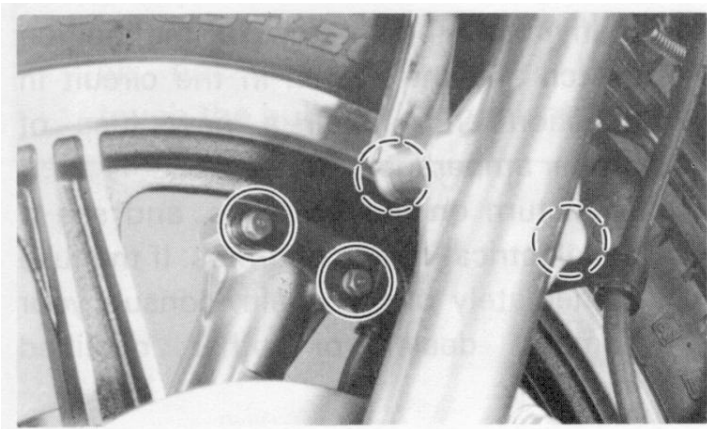

3. Remove the cotter pin and wheel axle nut.

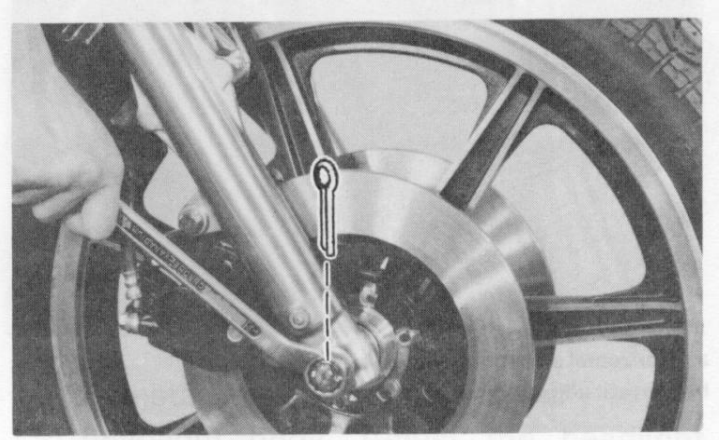

4. Loosen the wheel axle holder nuts.
5. Remove the axle shaft, In this case, make sure the motorcycle is properly supported.

NOTE: _____

Do not depress the brake lever when the wheel is off the motorcycle as the brake pads will be forced to shut.

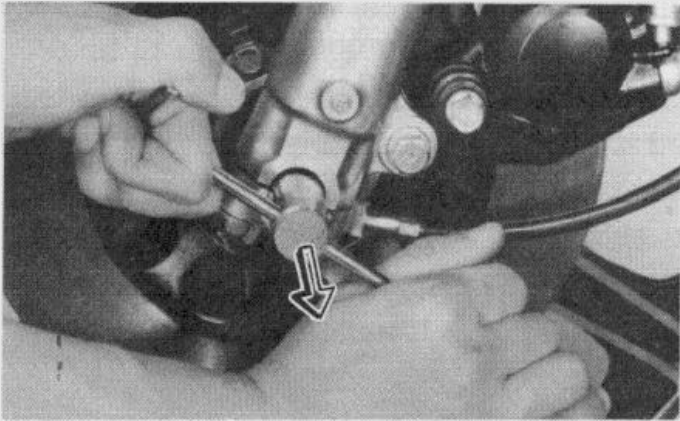

6. Lower the wheel until the discs come off the calipers. Turn the calipers outward so they do not obstruct the wheel and remove the wheel.

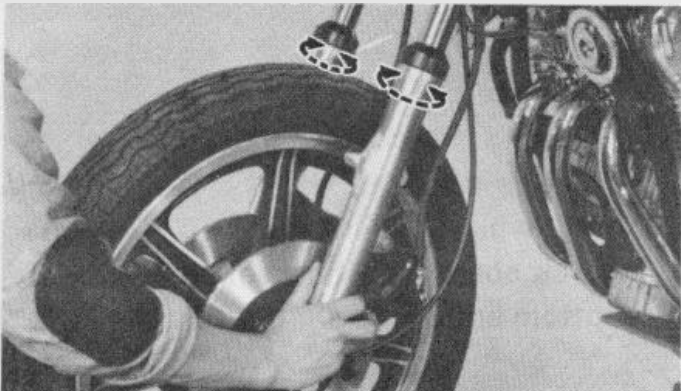

7. During reassembly, check the following:
- Make sure the projecting portion (torque stopper) of the speedometer housing is positioned correctly.

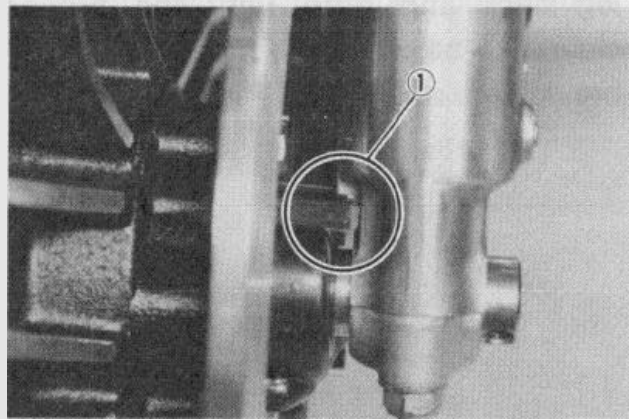

1. Torque stopper

- Tighten the axle nut and install a new cotter pin.

Axle nut torque: 10.5 m-k_g (76.0 ft-lb)

- Install the front fender.

- d. Before tightening the holder nuts, stroke the front forks several times to make sure of proper fork operation. With the axle holder nuts loose, work the left fork leg back and forth until the proper clearance between the disc and caliper bracket are obtained.

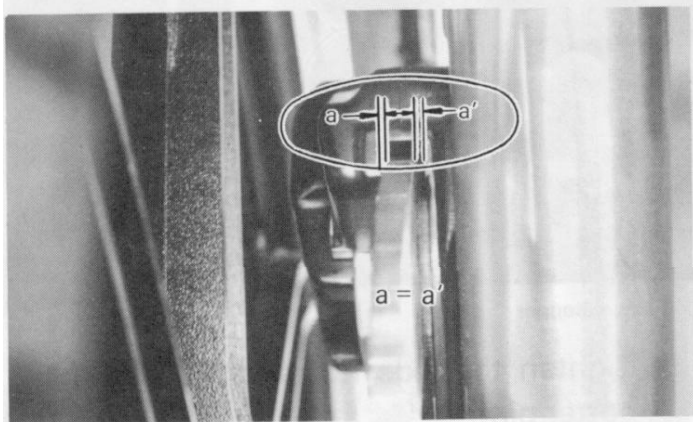

- e. Tighten the axle holder nuts. First tighten the nut on the front end of the axle holder, then tighten the nut on the rear end.

Axle holder nut torque:
2.0 m·kg (14.5 ft·lb)

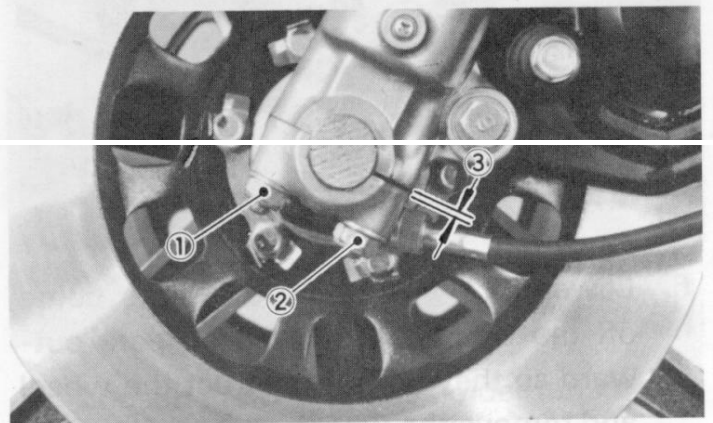

1 1st 2. 2nd 3 Gap

Rear wheel removal

1. Place the motorcycle on the side stand, and remove both the top and bottom nuts which mount the left side rear shock absorber. Then set free only the bottom end of the shock absorber.

2. Hook one end of the wire tool (contained in the owner's tool kit) to the hook attached to the frame.
3. Apply your weight to the rear part of the seat, and compress the rear shock absorbers by pulling up the right side of the swing arm with your hand, then hook the other end of wire tool to the swing arm as shown.

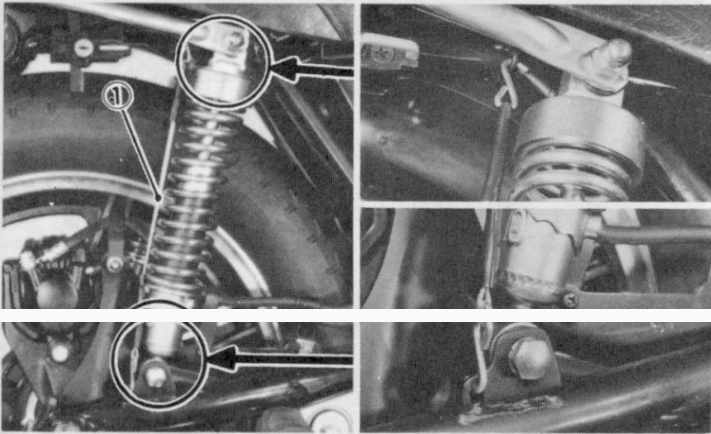

1. Wire tool

4. With the wire tool in this position, place the motorcycle on the center stand.
5. Remove the seat and unscrew the rear fender installation bolts until their threaded portion is completely out. Reinsert those bolts as stoppers to hold the rear fender up.

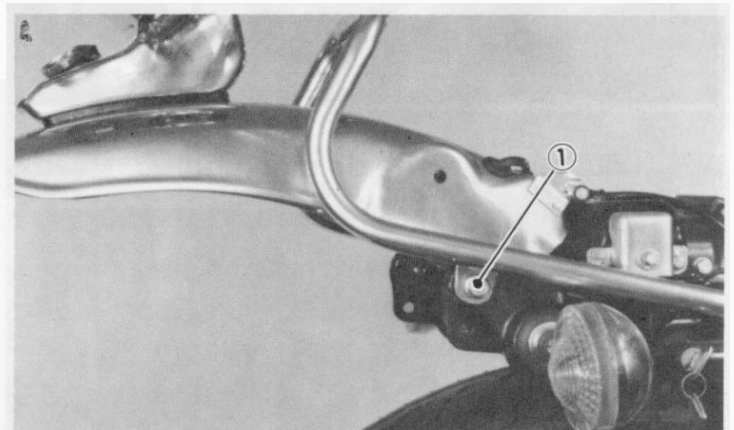

1. Installation bolts

6. Remove the axle nut cotter pin and axle nut.

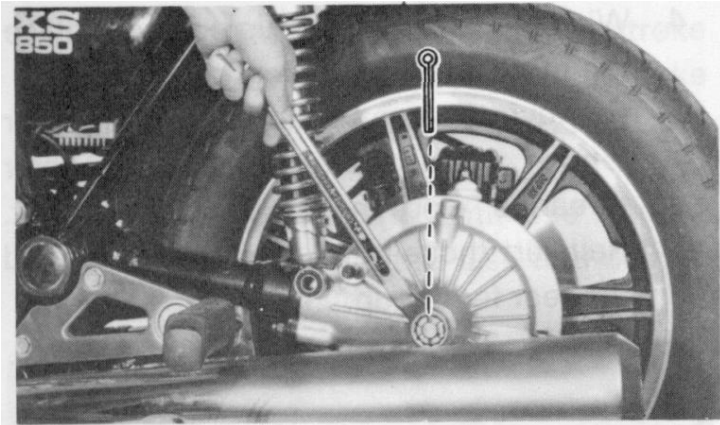

7. Loosen the rear axle pinch bolt.

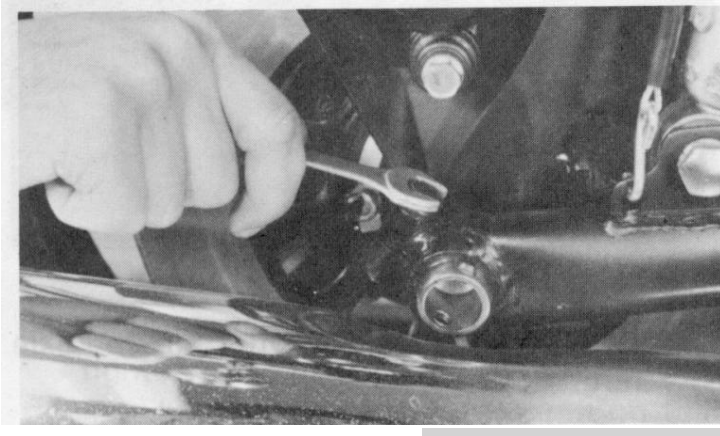

8. While supporting the brake caliper, pull out the rear axle.

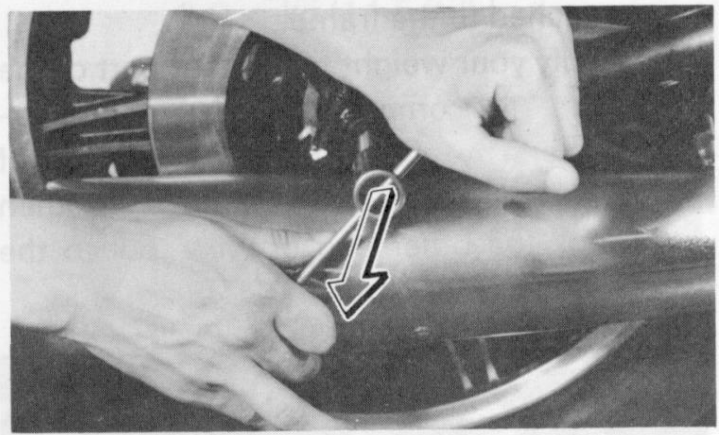

9. Pull out the rear brake torque stopper plate from where it is retained on the rear arm. Next, suspend the caliper assembly with the big end of the wire tool (contained in the owner's tool kit) hanging on the rear stay and the small end on the metal area of the brake caliper hose joint.

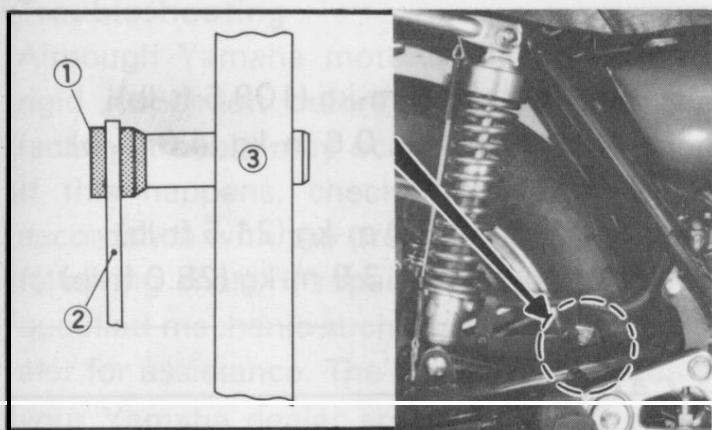

1. Rubber retainer

3. Rear arm

2. Torque stopper plate

10. Move the wheel to the right side to separate it from the final gear case and remove the rear wheel.

NOTE: _____
 Do not depress the brake pedal when the wheel is off the motorcycle as the brake pads will be forced to shut.

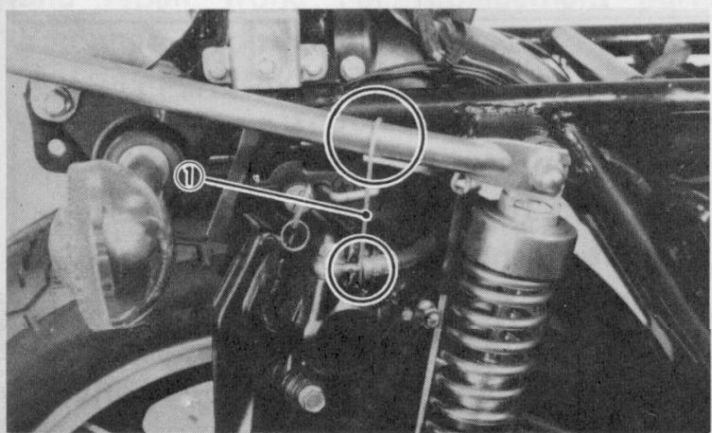

1 Wire

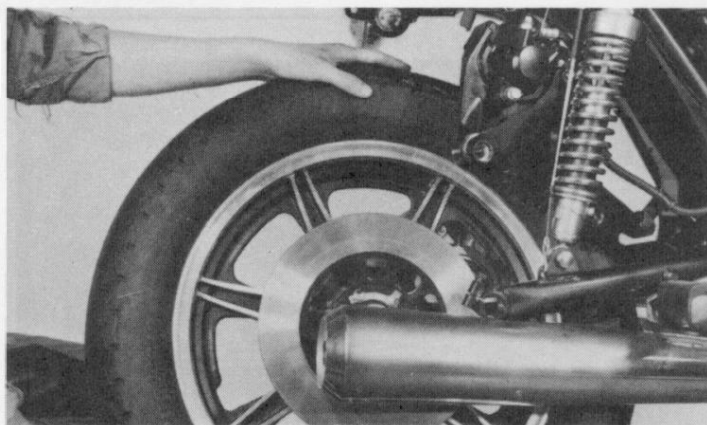

11. To install the rear wheel, reverse the removal procedure.

NOTE:

Before installing the rear wheel, apply a light coating of lithium base grease to the final gear case splines.

When installing the rear wheel, be sure the splines on the wheel hub fit into the final gear case.

Make sure there is enough gap between the brake pads before inserting the brake disc.

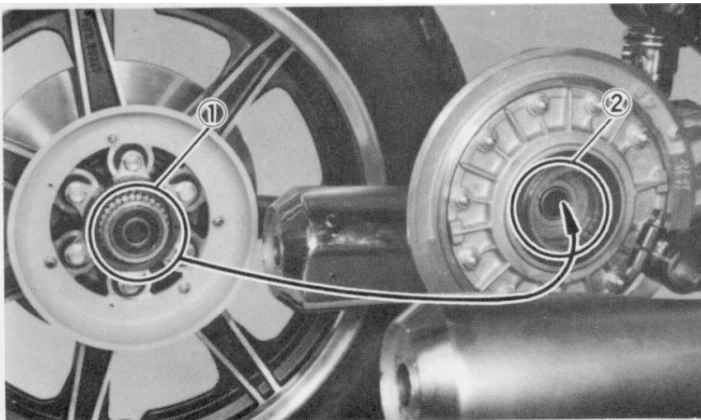

- 1. Rear wheel hub splines
- 2. Final gear case splines

Tightening torque:

Axle nut: 15.0 m-k \ddot{g} (108.5 ft-lb)

Axle pinch bolt: 0.6 m-k \ddot{g} (4.0 ft-lb)

Shock absorber:

Top mount: 3.0 m-k \ddot{g} (21.5 ft-lb)

Bottom mount: 3.9 m-k \ddot{g} (28.0 ft-lb)

-CAUTION:

Always use a new cotter pin on the rear axle nut.

-Carburetor adjustment:

The carburetor is a vital part of the engine and its emission control system. Adjusting should be left to your Yamaha dealer or other qualified mechanic with the professional knowledge, specialized data and equipment to do so properly.

Troubleshooting

Although Yamaha motorcycles are given a rigid inspection before shipment from the factory, trouble may occur during operation. If this happens, check the motorcycle in accordance with the procedures given in the following chart. If repair is necessary, ask a qualified mechanic such as your Yamaha dealer for assistance. The skilled technicians at your Yamaha dealer are trained and equipped to perform the necessary maintenance and repair work. For replacement parts, Yamaha recommends you use Genuine Yamaha Parts, or parts you know are equivalent in quality.

Any problem in the fuel, compression or ignition system can cause poor starting, excessive emissions, engine damage, or loss of power while riding. The troubleshooting chart describes a quick and easy series of system checks to locate the problem.

Troubleshooting chart

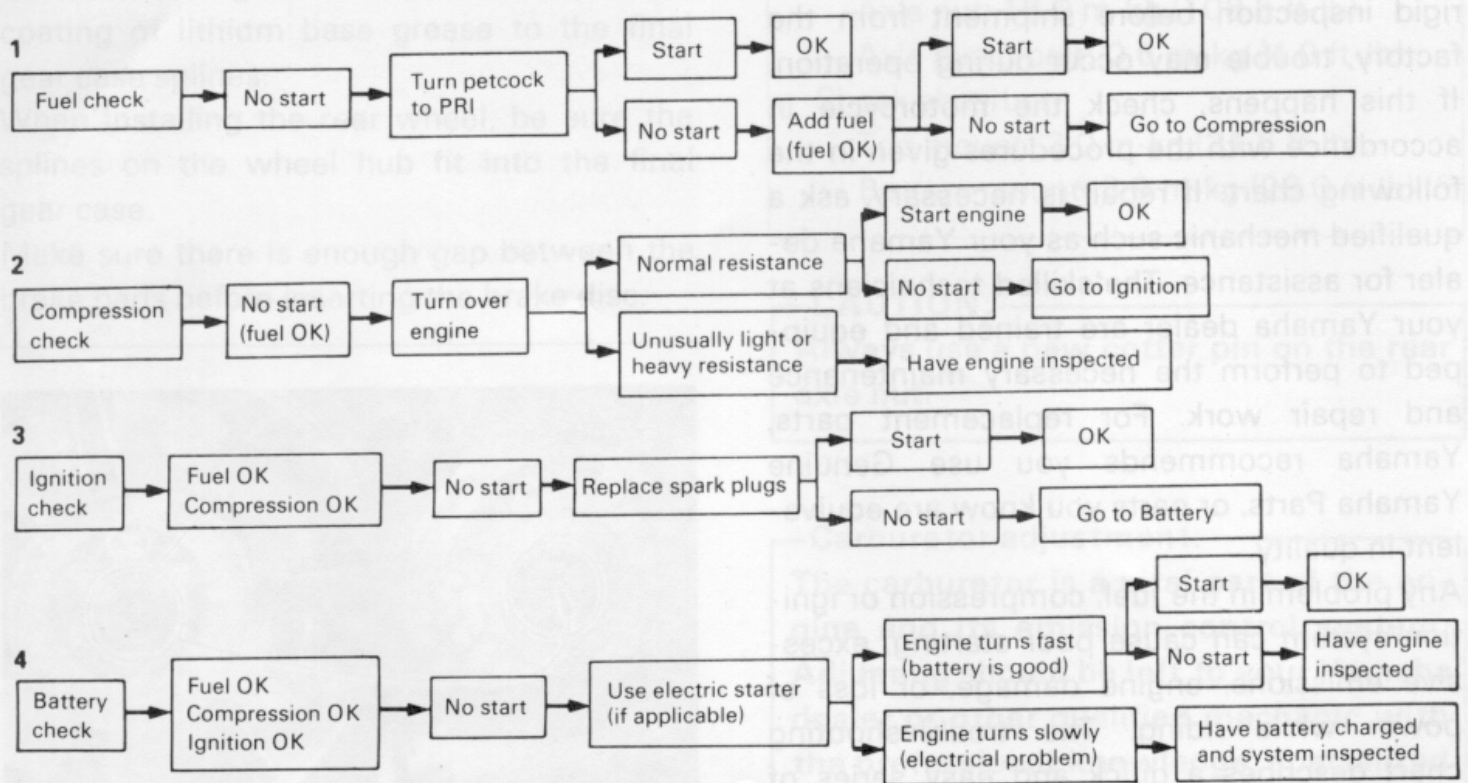

MISCELLANEOUS

Consumer information

STOPPING DISTANCE

These figures indicate braking performance that can be met or exceeded by the vehicles to which they apply. without locking the wheels. under different conditions of loading and with partial failures of the braking system The information presented represents results obtainable by skilled drivers under controlled road and vehicle conditions and the information may not be correct under other conditions.

Description of vehicles to which this table applies. Yamaha motorcycle XS850G

A. Fully Operational Service Brake

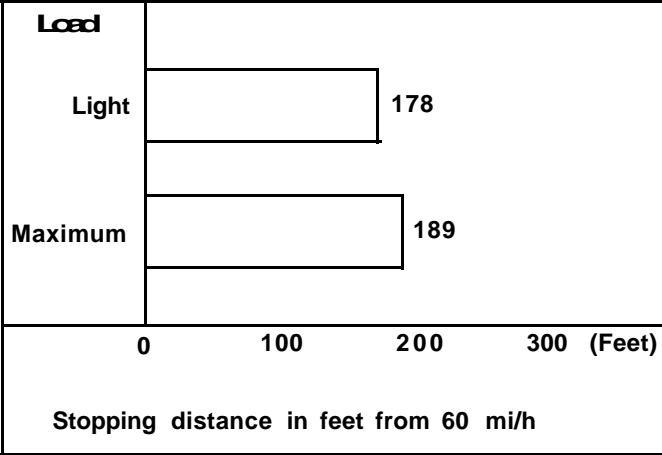

NOTE:

The statement above is required by U.S. Federal law. Partial failures of the braking system do not apply to this chart.

ACCELERATION AND PASSING ABILITY

These figures indicate passing times and distances that can be met or exceeded by the vehicles to which they apply in the situations diagrammed below.

The low-speed pass assumes an initial speed of 20 mi/h and a limiting speed of 35 mi/h. The high-speed pass assumes an initial speed of 50 mi/h and a limiting speed of 80 mi/h.

NOTICE: The information presented represents results obtainable by skilled drivers under controlled road and vehicle conditions, and the information may not be correct under other conditions.

Description of vehicles to which this table applies Yamaha motorcycle XS850G

Summary table

Low-speed pass	351 feet: 7.1 seconds
High-speed pass	868 feet: 8.1 seconds

LOW-SPEED

INITIAL
SPEED 20 mi/h

LIMITING
SPEED: 35 mi/h

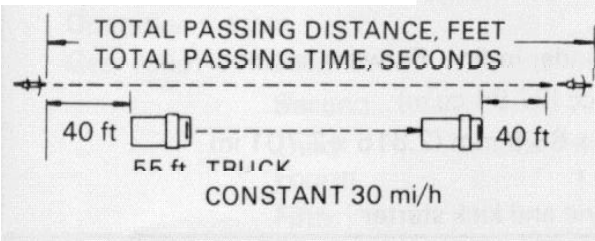

HIGH-SPEED

INITIAL
SPEED 50 mi/h

LIMITING
SPEED. 80 mi/h

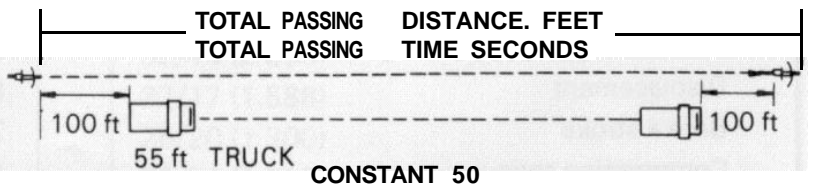

CLEANING AND STORAGE

A. CLEANING

Frequent thorough cleaning of your motorcycle will not only enhance its appearance but will improve general performance and extend the useful life of many components.

1. Before cleaning the motorcycle:
 - a. Block off end of exhaust pipe to prevent water entry: a plastic bag and strong rubber band may be use.
 - b. Make sure spark plug and gas cap are properly installed.
2. If engine case is excessively greasy. apply degreaser with a paint brush. Do not apply degreaser to wheel axles.
3. Rinse dirt and degreaser off with a garden hose, using only enough hose pressure to do the job. Excessive hose pressure may cause water seepage and

contamination of wheel bearings, front forks, brake calipers, and transmission seals. Many expensive repair bills have resulted from improper use of high pressure detergent applications such as those available in coin-operated car washes.

4. Once the majority of the dirt has been hosed off, wash all surfaces with warm water and mild, detergent type soap. An old tooth brush or bottle brush is handy to reach hard-to-get-to places.
5. Rinse motorcycle off immediately with clean water and dry all surfaces with a chamois, clean towel, or soft absorbent cloth.
6. Chrome-plated parts such as handlebars, fenders, forks. etc., may be further cleaned with automotive chrome cleaner.
7. Clean the seat with a vinyl upholstery cleaner to keep the cover pliable and glossy.

8. Automotive-type wax may be applied to all painted and chrome-plated surfaces. Avoid combination cleaner-waxes. Many contain abrasives which may mar paint or protective finish on the fuel tank and side covers.
9. After finishing, start the engine immediately and allow to idle for several minutes.

B. STORAGE

Long term storage (60 days or more) of your motorcycle will require some preventive procedures to insure against deterioration. After cleaning the machine thoroughly, prepare for storage as follows:

1. Drain fuel tank, fuel lines, and carburetor float bowl.
2. Remove empty fuel tank, pour a cup of **10W/30** or 20W/40 motor oil in tank. shake the tank to coat the inner surfaces thoroughly and drain off excess the oil. Reinstall the tank.

3. Remove the spark plug. pour about one tablespoon of 10W/30 or 20W/40 motor oil in the spark plug hole and re-install the spark plug. Kick the engine over several times (with the ignition off) to coat the cylinder walls with oil.

-WARNING:

When using starter motor to crank the engine, remove spark plug wires and ground them to prevent sparking.

4. Lubricate all control cables.
5. Block up the frame to raise both wheels off the ground.
6. Tie a plastic bag over the exhaust pipe outlet to prevent moisture entering.
7. If storing in humid or salt-air atmosphere, coat all exposed metal surfaces with a light film of oil. Do not apply oil to any rubber parts or the seat cover.
8. Remove the battery and charge it. Store it in a dry place and recharge it once a

month, Do not store the battery in an excessively warm or cold place (less than 0°C (32°F) or more than 30°C (86°F)).

NOTE: _____

Make any necessary repairs before storing the motorcycle.

SPECIFICATIONS

General specifications

MODEL	XS850G
Dimension: Overall length Overall width Overall height Wheelbase Minimum road clearance	2,175 mm (85.6 in) 900 mm (35.4 in) 1,190 mm (46.9 in) 1,450 mm (57.1 in) 140 mm (5.5 in)
Weight: Net	241 kg (531 lb)
Performance: Minimum turning radius Climbing capacity	2,400 mm (94.5 in) 26°
Engine: Type Engine model Cylinder Displacement Bore x stroke Compression ratio Starting system	4 stroke. gasoline. air-cooled, DOHC 3J3 3-cylinder in-line, Forward inclined 826 cc (27.94 cu.in) 71.5 x 68.6 mm (2.815 x 2.701 in) 9.2: 1 Electric and kick starter

MODEL	XS850G
Ignition system Fuel tank capacity Engine oil quantity Lubricating system Battery type/capacity Generator Spark plug Carburetor Air cleaner Clutch type	Battery ignition (Full transistor ignition) Total: 17 lit (4.5 US gal) Reserve: 3 lit (0.8 US gal) Total amount: 3.7 lit (3.91 US qt) Periodic oil change: 2.8 lit (2.96 US qt) Wet sump YB14L/12V, 14 A H A.C. generator BP7ES (NGK) or N-7Y (CHAMPION) HSC34-II x 3 Dry type element Wet, multiple-disc
Transmission: Primary reduction system Primary reduction ratio Secondary reduction system Secondary reduction ratio Gear box type Operation system Gear ratio: First Second Third Fourth Fifth	HY-VO chain + gear 45/27 (1.666) Shaft drive $35/31 \times 19/18 \times 32/11 = 3.466$ Constant mesh, 5-speed forward Left foot operation 32/14 (2.285) 27/17 (1.588) 26/20 (1.300) 23/21 (1.095) 22/23 (0.956)

MODEL		XS850G
Chassis:		
Frame type		Tubular. double-cradle
Steering:	Caster	27°
	Trail	131 mm (5.16 in)
Tire size:	Front	3.25H 19-4PR
	Rear	4.50H 17-4PR
Braking system:	Front	Disc brake/Right hand operation
	Rear	Disc brake/Right foot operation
Suspension:	Front	Telescopic fork (Pneumo-mechanical)
	Rear	Swing arm
Shock absorber:	Front	Coil/air spring, oil damper
	Rear	Coil spring, oil damper
Electrical:		
Headlight		1 12V. 60W/55W (Quartz bulb)
Tail/brake light		12V. 8W (3CP)/27W (32CP) x 2
Flasher light		12V. 27W (32CP) x 4
Pilot lights:	Flasher	12V. 3.4W x 2
	High beam	12V. 3.4W x 1
	Neutral	12V. 3.4W x 1
	Headlight outage	12V. 3.4W x 1
	Oil pressure	12V. 3.4W x 1
	Meter light	12V. 3.4W x 2